



**GLASS DOOR PARTS • CUTTING BOARDS •
STRIP CURTAINS • HARDWARE • GASKETS**

SAVE TIME, ORDER ONLINE

www.gasketsunlimited.com

Phone: (877) 542-7538 • Fax: (877) 503-7443 • Email: orders@gasketsunlimited.com



HOWTO ORDER

HOWTO ORDER



Call (877) 542-7538

Monday – Friday • 8:30AM – 5:00PM EST



Email Us! orders@gasketsunlimited.com

Order Online www.gasketsunlimited.com

Save Time Order Online!

Place orders online via our distributor only website www.GasketsUnlimited.com.

Contact us if you need your login credentials.

Prices 40-60% Below OEM

Our gaskets are OEM Quality, but not OEM price! Start saving now by calling us to place an order or set up your online account.

Chat With Us Online!

Have a question? Our online chat feature is great for quick answers to your questions.

Log in to our website www.GasketsUnlimited.com and look at the lower left of your screen. We are ready to help Monday through Friday 8:30AM- 5:00PM EST.

QUICK CATALOG REFERENCE

We want to make using our catalog easy! Review this catalog guide with example pages for help on how to use it and find the gasket for your equipment easily!

HARDWARE pgs. 3-22

Need any additional hardware for your refrigeration equipment? Check here for walk-in and reach-in door handles, latches, hinges, door releases, strip curtains, and door sweeps. Don't see what you need? Give us a call!



CUSTOM GASKETS pgs. 23-33

Not sure of the make and model of your equipment? Don't worry! Use this section to match up the correct gasket profile. You can call us to place your order or use the custom gasket order form in the back!



GASKETS BY MANUFACTURER pgs. 34-86

This section contains a list of manufacturers in alphabetical order. It is a reference guide for gaskets made to the manufacturer's specifications. You can check by dimensions, model number, and OEM #. You can also give us a call with your model and serial number to verify the correct gasket- Let us do the leg work!



HOW TO MEASURE A GASKET pgs. 91

All of our measurements are done from outside edge to opposite outside edge. We make measuring a gasket easy with this simple how-to guide.



HELPFUL HARDWARE TIPS pgs. 92-95

Not sure if you need a hinge or latch with an offset? Look here to double check! We also walk you through reversing different types of hinges.



FOR A MORE DETAILED PAGE LISTING GO TO THE NEXT PAGE FOR THE TABLE OF CONTENTS

TABLE OF CONTENTS

Hardware	3	Hobart	54
Walk-In Door Hardware	3	Hoshizaki	55
Glass Door Hardware	4	Kairak	55
Kason Walk-In Hinges	6	Kelvinator	56
Kason Walk-In Lighting	8	Kolpak	56
Kason Walk-In Door Closers	9	La Rosa	58
Kason Walk-In Latches & Locks	11	Leer	59
Kason Walk-In Door Releases	13	Masterbilt	60
Kason Reach-In Hinges	14	McCall	62
Kason Reach-In Latches & Locks	16	Nor-Lake	63
Kason Maintenance & Accessories	18	Perlick	65
Strip Curtains	20	Randell	65
Walk-In Strip Curtains	20	Schott Gemtron	68
Kason Strip Curtains	21	Silver King	72
Custom Gaskets	23	Styleline	73
Dart Style Gaskets	23	Thermo-Kool	75
Push-In Style Gaskets	31	Traulsen	75
Compression Style Gaskets	33	True Manufacturing	79
Screw-In Style Gaskets	34	Turbo Air	81
Retainer Style Gaskets	35	Victory	82
Santoprene Gaskets	35	Vollrath	84
Gaskets By Brand	34	W.A. Brown	85
Alta-Shaam	35	Wasserstrom	86
Anthony	35	Zero Zone	86
Arctic	40	Custom Gasket Profile Numbers	87
Ardco	40	Custom Retainer Profile Numbers	90
Bally	42	How to Measure a Gasket	91
Beverage-Air	43	Helpful Hardware Tips	92
Brown	45	Custom Gaskets Order Form	96
Continental	46		
Delfield	47		
Florida Stainless	53		
Glastender	53		

WALK-IN & GLASS DOOR HARDWARE

Door Heaters & Track



74-0009, 74-0010



74-0011



74-0256

**CUSTOM
SIZES
AVAILABLE**

SKU	Description
74-0009	Heater Wire Trim –Track & Cap – 3/4" - 8' sticks
74-0010	Heater Wire Trim –Track & Cap – 1" - 8' sticks
74-0011	Aluminum Door Heater Wire- 230" - 115v- 8 ohms/ft- 18" Standard Leads
74-0256	Fiberglass Door Heater Wire- 230" - 115v- 8 ohms/ft- 18" Standard Leads

Hold Open Assembly BLK New 95 to present ANTHONY



SKU	Color	Part #
03-2006	Black	02-14649-0001*

Hinge Pin w/ lead ANTHONY



SKU	Color	Part #
03-2007	Silver	60-10847-0004*

Heater Wire Resistance Limiter



75-9999

In line resistance thermostat that opens hot side circuit if wire gets too hot through excessive amperage rating.

Hinge Pin w/3 leads ANTHONY



SKU	Color	Part #
03-2004	Black	60-10847-0003*

Hold Open ANTHONY



SKU	Color	Part #
03-2005	Black	15-14707-0001*

*Aftermarket

GLASS DOOR HARDWARE

Torque Master Reversible ANTHONY



SKU	Color	Part #	SKU	Color	Part #
03-2001	Black	02-10568-0003*	03-2002	Silver	02-10568-0001*

29" Torque Rod ANTHONY



SKU	Part #
02-10308-0007	89 to present 02-10308-0007*

29" Torque Rod SCHOTT GEMTRON



SKU	Part #
82-0302	44QLASM1*

Torque Adjuster SCHOTT GEMTRON



SKU	Color	Part #	SKU	Color	Part #
82-0300	Black	44QLASM20-BK*	82-0301	Silver	44QLASM20*

Top Hinge 3 Wire SCHOTT GEMTRON



SKU	Part #
82-0303	44QLASM21-1 HPBK*

Top Hinge Pin no leads or wires SCHOTT GEMTRON



SKU	Part #
82-0304	44QLASM22 BK*

Hinge Pin Receptacle Single Three Wire SCHOTT GEMTRON



SKU	Part #
82-0305	44QL30-2 HP*

Hinge Pin Receptacle Double Three Wire SCHOTT GEMTRON



SKU	Color	Part #
82-0306	Black	44QL28-2 HP*

*Aftermarket

GLASS DOOR HARDWARE

Electrical Access Cover SCHOTT GEMTRON



SKU	Part #
82-0310	44QL34*

Hold Open Bushing a.k.a. "Sleeve" SCHOTT GEMTRON



SKU	Part #
82-0307	44PUR021-35*

Clover Leaf Plug a.k.a. "Hole Plug" SCHOTT GEMTRON



SKU	Part #
82-0308	44QL36*

Top Hinge Repair Kit 2907-5705

STYLELINE



SKU	Part #
53-0071	2907
53-0072	5705

Bottom Hinge Repair Kit 5548 STYLELINE



SKU	Part #
53-0070	5548-KIT

Hinge Pin Filler Plug a.k.a. "Safety Plug" SCHOTT GEMTRON



SKU	Part #
82-0309	44QL32*

Bottom Hinge Repair Kit 2908 STYLELINE



SKU	Part #
53-0073	2908

Offset Handle Kit Combo STYLELINE



SKU	Color	Part #
53-0067	Bright Silver	9455S
53-0068	Bright Black	9455L
53-0074	Satin Black	5680B
53-0075	Satin Black	9455B
53-0076	Satin Black	5678B

*Aftermarket

Bottom Hinge Repair Kit 9360 STYLELINE



SKU	Part #
53-0069	9360-KIT

KASON HARDWARE

1241 Heavy Duty Double Knuckle Hinge

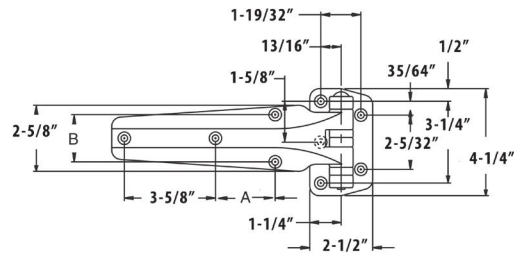

SKU	Description
75-0133	Right-Handed

1245 Reversible Cam-Rise Hinge

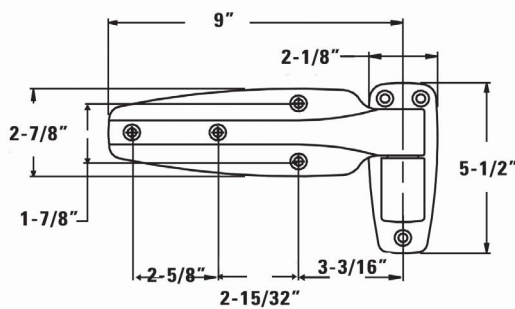

SKU	Offset	Finish
75-0144	1-1/8"	Brushed Chrome
75-0145	1-1/4"	Brushed Chrome
75-0146	1-3/8"	Brushed Chrome
75-0147	1-1/2"	Brushed Chrome
75-0148	1-5/8"	Brushed Chrome
75-0149	1-3/4"	Brushed Chrome
75-0150	1-7/8"	Brushed Chrome
75-0252	2"	Brushed Chrome
75-0143	Flush	Brushed Chrome
75-0138	1-1/8"	Polished Chrome
75-0139	1-1/4"	Polished Chrome
75-0140	1-3/8"	Polished Chrome
75-0079	1-1/2"	Polished Chrome
75-0141	1-5/8"	Polished Chrome
75-0080	1-3/4"	Polished Chrome
75-0142	1-7/8"	Polished Chrome
75-0081	2"	Polished Chrome
75-0077	Flush	Polished Chrome

1249 Spring Assisted Hinge

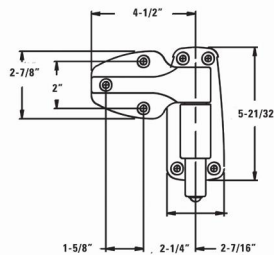

SKU	Description
75-0135	Flush Offset

KASON HARDWARE

1248 Reversible Cam-Rise Spring Assisted Hinge

KASON

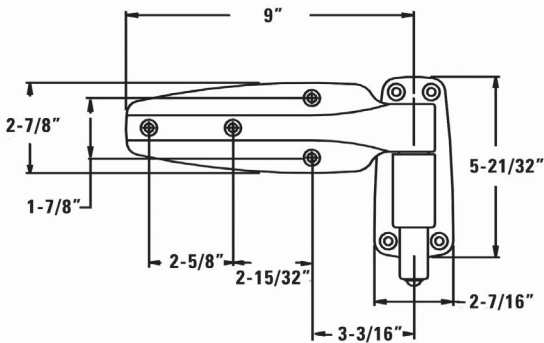

SKU	Offset	Finish
75-0151	Flush	Polished Chrome
75-0087	1-1/8"	Polished Chrome
75-0152	1-1/4"	Polished Chrome
75-0085	1-3/8"	Polished Chrome
75-0084	1-1/2"	Polished Chrome
75-0153	1-5/8"	Polished Chrome
75-0083	1-3/4"	Polished Chrome
75-0154	1-7/8"	Polished Chrome
75-0086	2"	Polished Chrome
75-0155	Flush	Brushed Chrome
75-0156	1-1/8"	Brushed Chrome
75-0157	1-1/4"	Brushed Chrome
75-0158	1-3/8"	Brushed Chrome
75-0159	1-5/8"	Brushed Chrome
75-0160	1-3/4"	Brushed Chrome
75-0161	1-7/8"	Brushed Chrome

1255/1256 Spring Kit

KASON



SKU	FINISH
75-0078	Brushed Chrome
75-0136	Polished Chrome

1255 Pacesetter Hinge

KASON

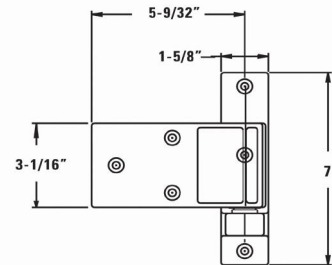

SKU	Description	Finish
75-0088	Textured Panel	Brushed Chrome
75-0089	Smooth Face	Polished Chrome

1256 Long Strap Hinge

KASON

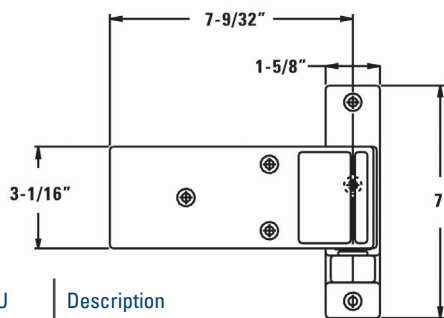

SKU	Description
75-0103	Long Strap Hinge

Note:

Mounting Hardware
NOT
Included

KASON HARDWARE

1277 Series Self Closing Heavy Duty Hinge

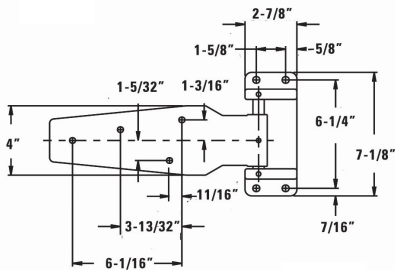

SKU	Description
75-0082	1-1/2" Offset

1802 Glass Globe

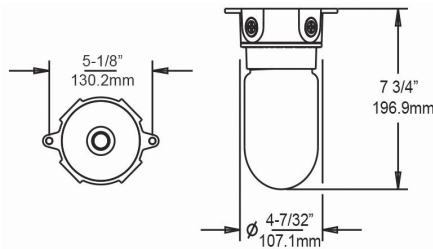

SKU	Description
75-0162	Glass Globe
75-0163	Chrome Wire Guard
75-0164	Junction Box
75-0165	Vaporproof Fixture with Glass Globe

1803 Lexan Globe



SKU	Description
75-0018	Vaporproof Fixture with Lexan Globe
75-0283	Lexan Globe

1804 Coated Globe



SKU	Description
75-0026	Vaporproof Incandescent Light Fixture with Coated Globe
75-0167	Surlyn Coated Glass Globe

1806 Series Fixtures



SKU	Description
75-0027	CFL Vaporproof Fixture with Lexan Globe and 1/2" NPT
75-0021	LED Fixture with Lamp and Optic Globe
75-0023	LED Replacement Lamp
75-0013	LED Adapter Retrofit Kit

1808 LED Fixture

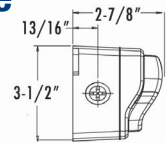

SKU	Description
75-0025	LED Fixture



1810 LED Light Fixture

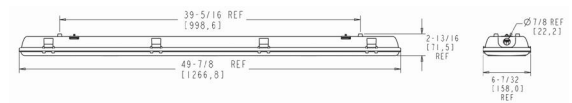

SKU	Description
75-0020	48" LED Light Fixture with Two Lamps
75-0024	48" High Output LED Light Fixtures

KASON HARDWARE

1901 Motion Sensor Light

KASON

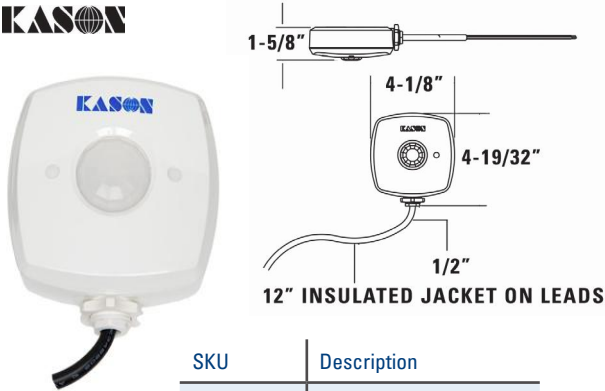

SKU	Description
75-0022	Motion Sensor Light

1805 Lexan Light Cover

KASON



SKU	Description
75-0168	Lexan Light Cover

1807 Fixture with Plastic Globe & 1/2" NPT

KASON

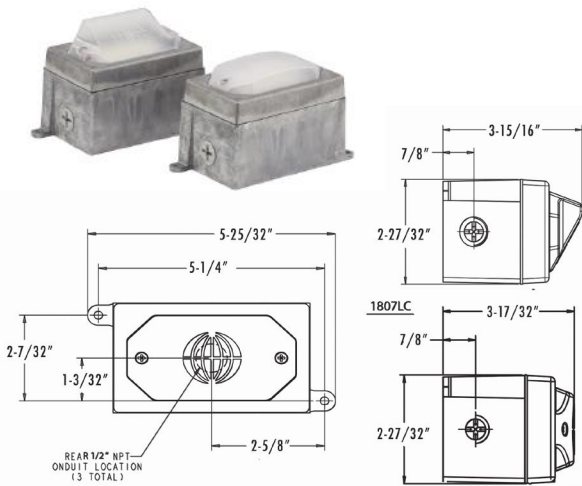

SKU	Description
75-0169	Fixture with Coated Glass Globe & 1/2" NPT

1093 Hydraulic Door Closer

KASON

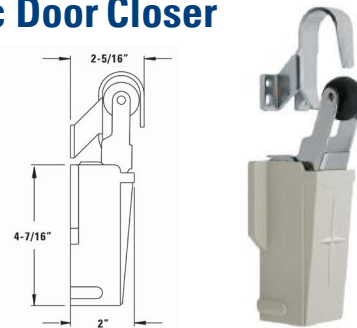

SKU	Description
75-0010	Hydraulic Door Closer with Flush Hook
75-0172	Hydraulic Door Closer with 1-1/8" Offset Hook

1094/1095 Hook

KASON



SKU	Description
75-0008	Flush Hook, Polished Chrome
75-0009	1-1/8" Offset Hook, Polished Chrome

1092 Hydraulic Door Closer

KASON

SKU	Description
75-0170	Hydraulic Door Closer with Flush Hook
75-0171	Hydraulic Door Closer with 1-1/8" Offset Hook

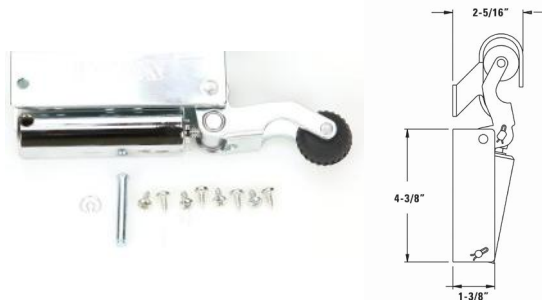

KASON HARDWARE

1094 Exposed Mount Door Closer



SKU	Description
75-0006	Exposed Mount SureClose Hydraulic Door Closer, Polished Chrome
75-0007	Concealed Mount Door Closer, Polished Chrome

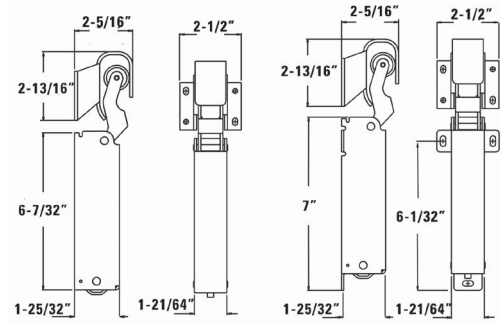

CONCEALED MOUNTING

EXPOSED MOUNTING

1095 Spring Action Door Closer



SKU	Description
75-0012	Spring Action Door Closer

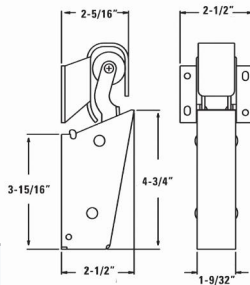

1096L Kason Door Closer

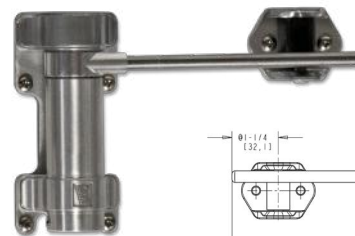

SKU	Description
75-0278	Adjustable Door Closer, Light, Maximum torque 132 in-lbs

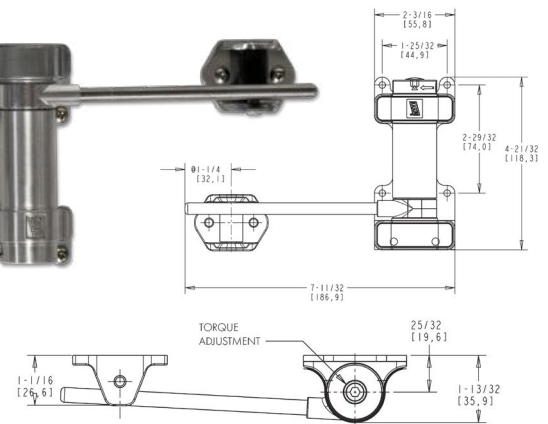

1096M Kason Door Closer

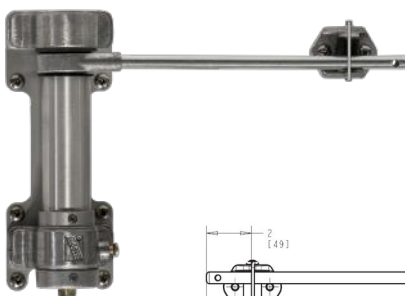

SKU	Description
75-0279	Adjustable Door Closer, Light, Maximum torque 132 in-lbs

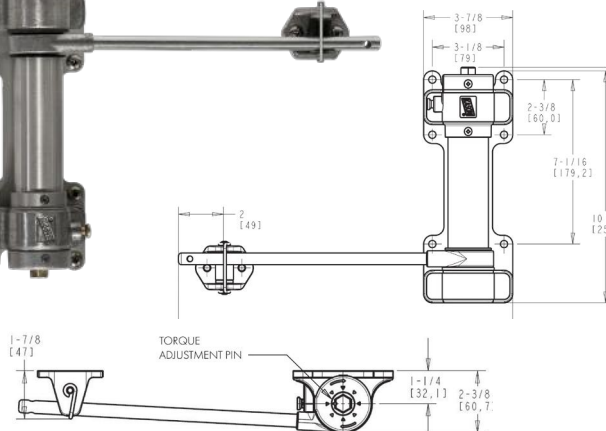

KASON HARDWARE

1097 Spring Action Door Closer for Doors Greater than 200lbs

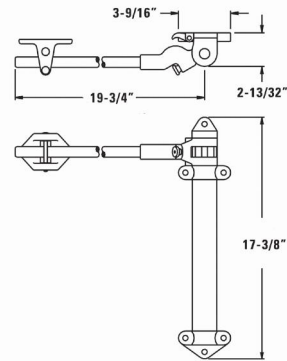
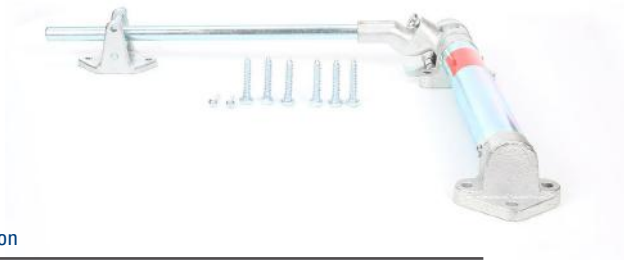

SKU	Description
75-0011	Spring Action Door Closer for Doors Greater than 200lbs

0058 SafeGuard Latches & Strikes



*Latch and strike sold separately

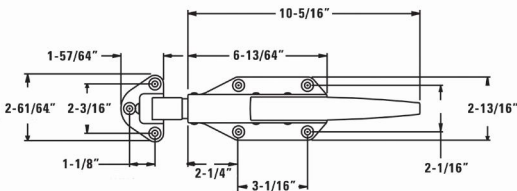

SKU	Description	Finish
75-0072	SafeGuard Strike, -1/8" - 1/4"	Polished Chrome
75-0066	SafeGuard Strike, 3/4" - 1 1/2"	Polished Chrome
75-0110	SafeGuard Strike, 1-3/4" - 2 1/2"	Polished Chrome
75-0071	SafeGuard Light Spring Latch with Cylinder Lock	Polished Chrome
75-0065	SafeGuard Standard Latch Body	Polished Chrome
75-0263	SafeGuard Strike, 1/8" - 1/4" Offset	Brushed Chrome
75-0258	SafeGuard Strike, 3/4" - 1 1/2" Offset	Brushed Chrome
75-0259	SafeGuard Strike Chrome 1-3/4" - 2 1/2"	Brushed Chrome
75-0260	SafeGuard Light Spring Latch with Cylinder Lock	Brushed Chrome
75-0262	SafeGuard Standard Latch Body	Brushed Chrome

0059 Roller Strike



SKU	Description
75-0174	Roller Strike, -1/8" x 1/4"
75-0175	Roller Strike, 3/4" x 1-1/2" Offset
75-0091	Roller Strike, 1-3/4" x 2-1/2"



KASON HARDWARE

0056 SafeGuard Latch

KASON *Latch and strike sold separately

SKU	Description	Finish
75-0068	Safeguard Latch Strike, 3" to 4" Offset	Polished Chrome
75-0069	Safeguard Latch Strike, -1/8 to 1/4" Offset	Polished Chrome
75-0070	SafeGuard Chrome Padlocking Latch Body	Polished Chrome
75-0107	SafeGuard Strike, 3/4" to 1-1/2" Offset	Polished Chrome
75-0108	SafeGuard Strike, 1-3/4" to 2-1/2" Offset	Polished Chrome
75-0253	Safeguard Latch Strike, 3" to 4" Offset	Brushed Chrome
75-0254	Safeguard Latch Strike, -1/8 to 1/4" Offset	Brushed Chrome
75-0255	SafeGuard Chrome Padlocking Latch Body	Brushed Chrome
75-0256	SafeGuard Strike, 3/4" to 1-1/2" Offset	Brushed Chrome
75-0257	SafeGuard Strike, 1-3/4" to 2-1/2" Offset	Brushed Chrome

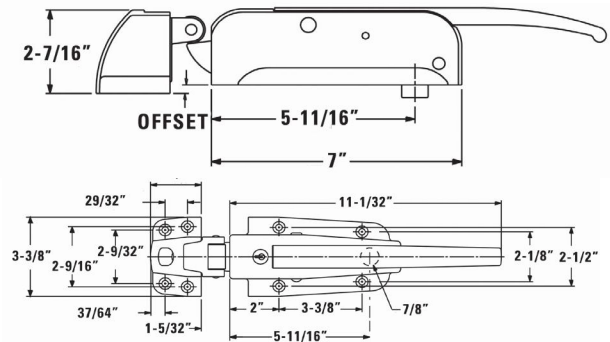

0078 SafeGuard Latch

KASON *Latch and strike sold separately

SKU	Description	Finish
75-0068	Safeguard Latch Strike, 3" to 4" Offset	Polished Chrome
75-0069	Safeguard Latch Strike, -1/8 to 1/4" Offset	Polished Chrome
75-0277	SafeGuard Chrome Padlocking Latch Body	Polished Chrome
75-0107	SafeGuard Strike, 3/4" to 1-1/2" Offset	Polished Chrome
75-0108	SafeGuard Strike, 1-3/4" to 2-1/2" Offset	Polished Chrome
75-0253	Safeguard Latch Strike, 3" to 4" Offset	Brushed Chrome
75-0254	Safeguard Latch Strike, -1/8 to 1/4" Offset	Brushed Chrome
75-0278	SafeGuard Chrome Padlocking Latch Body	Brushed Chrome
75-0256	SafeGuard Strike, 3/4" to 1-1/2" Offset	Brushed Chrome
75-0257	SafeGuard Strike, 1-3/4" to 2-1/2" Offset	Brushed Chrome

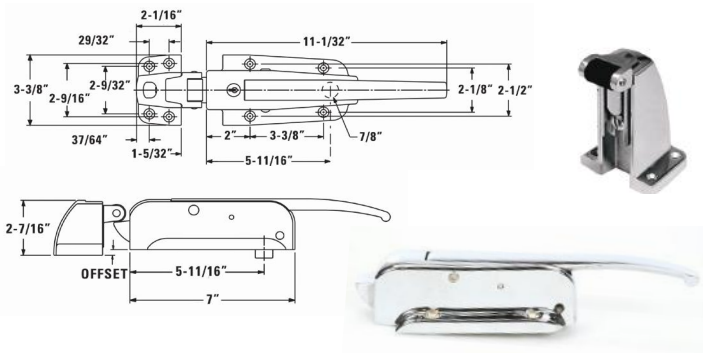

1229C Cylinder Locking Handle

KASON Finished in Polished Chrome

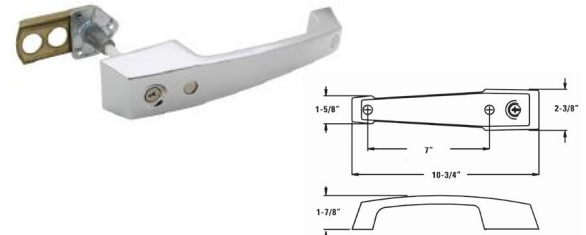

SKU	Description
75-0176	Cylinder Locking Handle with Inside Release & Freezer Kit

1236 Heavy Duty Lever Locking Handle

KASON

Finished in Polished Chrome

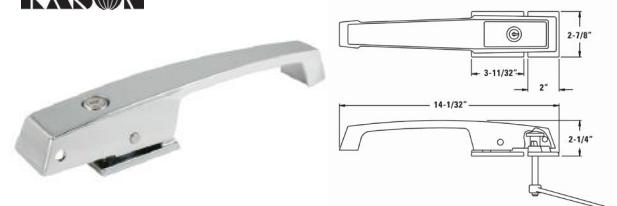

SKU	Description
75-0177	Heavy Duty Lever Locking Handle and LeverTurn Release

KASON HARDWARE

0481 Inside Release



SKU	Door Width	Variation	Latch Series
75-0199	1-1/2"	C	58, 77
75-0200	2-1/2"	A	56
75-0015	3"	B	45, 46, 50, 51, 52, 53

0489 Narrow Recessed Inside Release Handle with Safety Glow



SKU	Door Width	Variation	Latch Series
75-0276	2-3/4"	D	55XXL
75-0275	3-1/4"	C	58, 77
75-0202	4"	A	56

0486 Inside Bumper Guard



Mounts over existing 486 inside release cup. Inside release sold separately

SKU	Description
75-0277	486 Inside Bumper Guard

0486 Wide Recessed Inside Release Handle with Safety Glow



SKU	Door Width	Variation	Latch Series
75-0273	2-11/16"	D	55XXL
75-0272	3"	B	45, 46, 50, 51, 52, 53
75-0017	3-3/4"	A	56, 5656
75-0201	6"		58, 77

HOW TO SELECT YOUR INSIDE RELEASE HANDLE

Find your door thickness and match it with the inside release for that door thickness.

TABLE A

LATCHES	INSIDE RELEASE HANDLES
45, 46, 50, 51, 4545, 4646, 5050, 5151	480, 481B, 482B, 486B, 487B, 489B
52, 53	481B, 482B, 486B, 487B, 489B
55XXL	486D, 489D
56, 5656	480, 483, 481A, 482A, 486A, 487A, 489A
58, 77	481C, 482C, 486C, 487C, 489C

TABLE B

MINIMUM DOOR THICKNESS	INSIDE RELEASE HANDLES
1-1/2" (38.1 mm)	481C, 482C, 483, 487C
2-1/2" (63.5 mm)	481A, 482A, 487A
2-11/16" (68.3 mm)	486D
2-3/4" (69.9 mm)	489D
3" (76.2 mm)	481B, 482B, 486B, 486C, 487B
3-1/4" (82.6 mm)	489B, 489C
3-1/2" (88.9 mm)	480
3-3/4" (95.3 mm)	486A
4" (101.6 mm)	489A

KASON HARDWARE

1556 Power Spring Cartridge Assembly

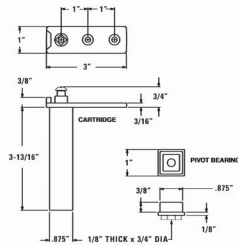

SKU	Description
75-0043	Power Spring Cartridge Assembly, Standard Clearance, 120 Degree Stop
75-0056	Power Spring Cartridge Assembly, Minimal Clearance, No Stop

1247 Cam Rise Spring Hinge

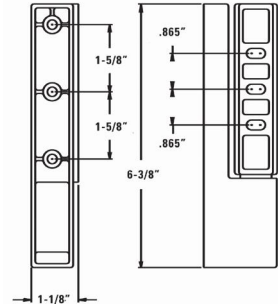

SKU	Description
75-0208	Cam Rise Spring Hinge

1267 Cam Rise Hinge



SKU	Description
75-0204	Cam Rise Hinge - Offset 3/16"
75-0205	Cam Rise Spring Hinge
75-0206	Switch Assy With Leads

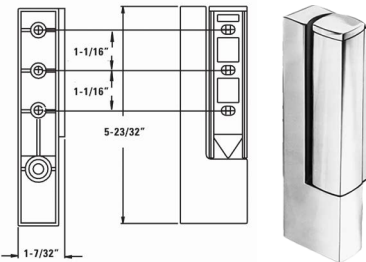

1269 Right Handed Hinge

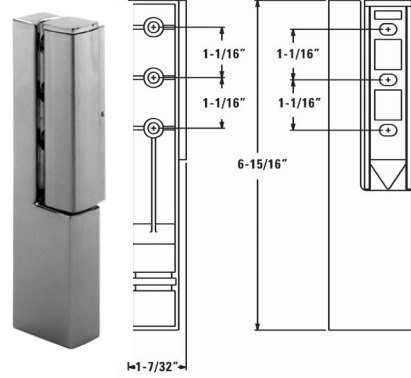

SKU	Description
75-0207	Right Handed Hinge, 1-5/8"

1367 Lift Off Hinge



75-0102



75-0101

SKU	Description
75-0101	Universal Replacement Cam Rise Hinge
75-0102	1367 Hinge Covers - Set of 2

1521 Bottom Pivot Hinge

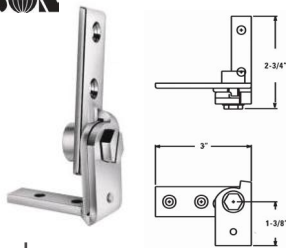

SKU	Description
75-0052	Bottom Left Handed Pivot Hinge
75-0053	Bottom Right Handed Pivot Hinge

1522 Top Pivot Hinge

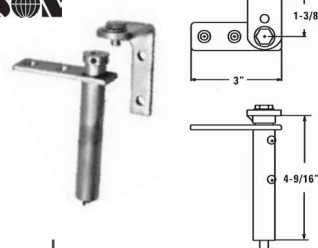

SKU	Description
75-0054	Top Left Handed Pivot Hinge
75-0055	Top Right Handed Pivot Hinge

0215 Reversible Cam Rise Hinge

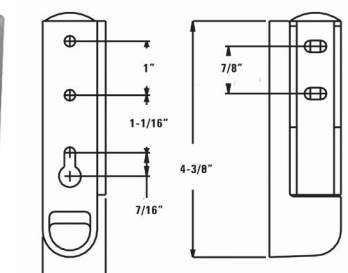

Chrome Finish

SKU	Description
75-0047	Reversible Cam-Rise Hinge, 1-1/4"

KASON HARDWARE

1467R Cam Rise Hinge

KASON

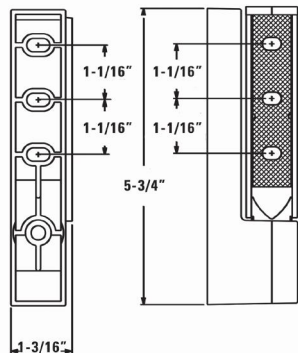

SKU	Description
75-0092	Nylon Cam, Set of 2- For Use on Beverage Air and Traulsen
75-0046	Complete Double Adjustable Cam-Rise Hinge

0217 Hinge Chrome

KASON

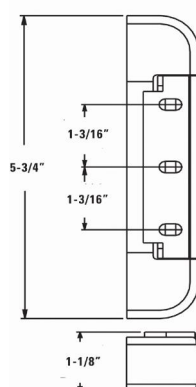

SKU	Description
75-0209	Hinge Chrome, 1-3/8"

0218 Adjustable Spring Hinge

KASON

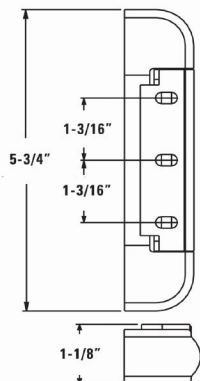

SKU	Description	Finish
75-0050	Adjustable Spring Hinge, 7/8"	Chrome
75-0045	Adjustable Spring Hinge Cartridge Kit	
75-0049	Adjustable Spring Hinge, 1-3/8"	Chrome

0220 Spring Hinge Assembly

KASON

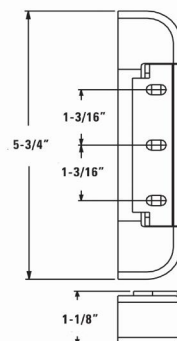

SKU	Description	Finish
75-0210	Spring Hinge Assembly, 1-1/8" without Spring	
75-0048	Spring Hinge Assembly, 1-1/8"	Chrome
75-0211	Spring Hinge Assembly, 1-3/8" without Spring	
75-0212	Spring Hinge Assembly, 1-3/8"	
75-0213	Spring Cartridge Kit	

1070 Right Hand Narrow Flange Hinge

KASON

SKU	Description
75-0214	Right Hand Narrow Flange Hinge

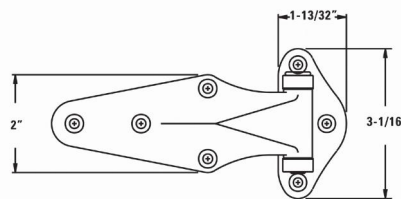

KASON HARDWARE

1216 Non-Rise Adjustable Hinge

KASON

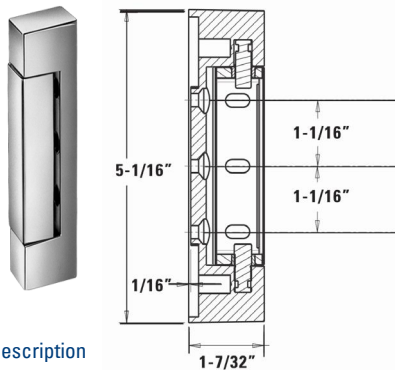

SKU	Description
75-0044	1-1/8" Offset
75-0042	Spring Cartridge Kit

1219 Adjustable Edgemount Hinge

KASON

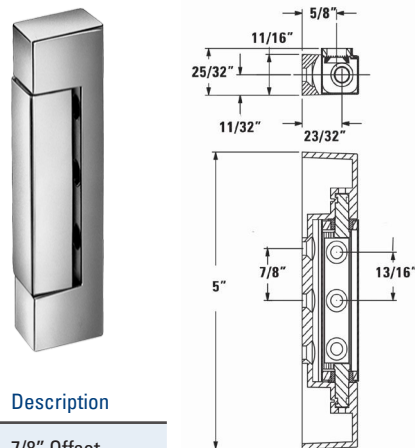

SKU	Description
75-0215	7/8" Offset

0930 Trigger Action Latch

KASON

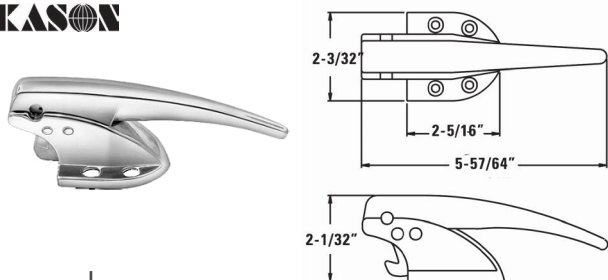

SKU	Description
75-0230	Trigger Action Latch with Adjustable Strike A
75-0231	Trigger Action Latch with 3-hole Micrometer Strike C

0533 Edgemount Mechanical

KASON



SKU	Description
75-0036	Edgemount Mechanical Strike
75-0232	Edgemount Mechanical Latch

0174 Universal Edgemount Mechanical Latch

KASON

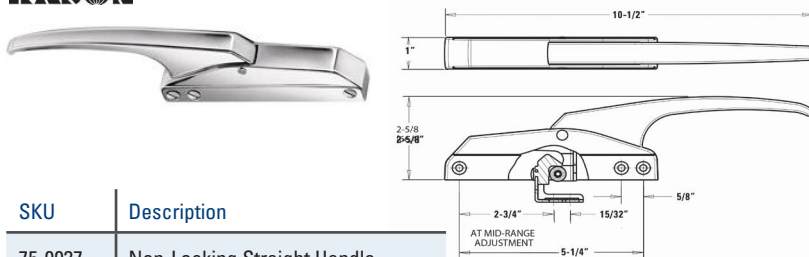

SKU	Description
75-0037	Non-Locking Straight Handle
75-0227	Non-Locking Offset Handle
75-0228	Offset Handle with Cylinder Lock
75-0229	Straight Handle with Cylinder Lock

0544 Compact Magnetic Edgemount Latch

KASON

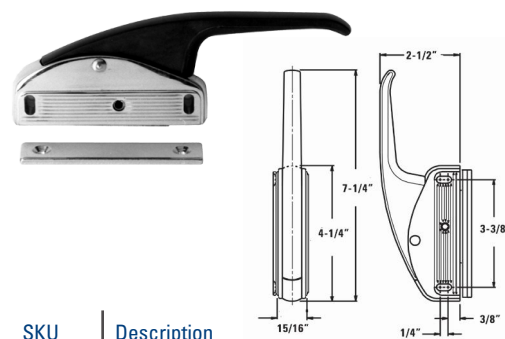

SKU	Description
75-0233	Compact Magnetic Edgemount Latch

KASON HARDWARE

0170 Composite Black Magnetic Latch

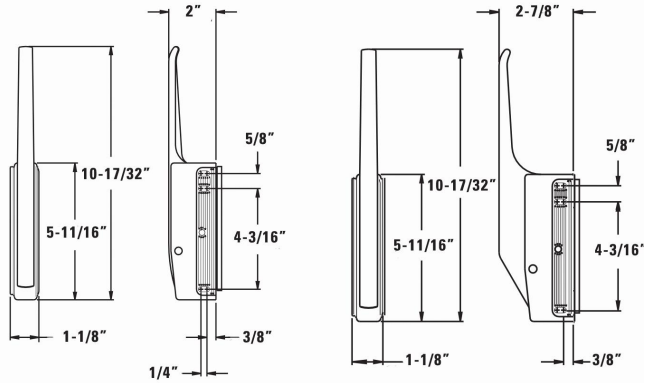
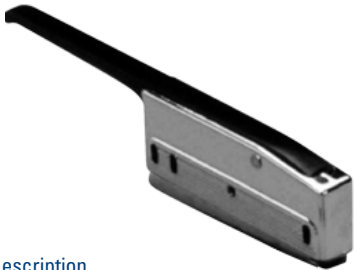

170 STRAIGHT DIE-CAST OR COMPOSITE HANDLE

170 COMPOSITE OFFSET HANDLE

SKU	Description	Offset
75-0216	Offset Composite Black Magnetic Latch	
75-0035	Straight Composite Black Magnetic Latch	Flush

0171 Magnetic Cylinder Locking Latch

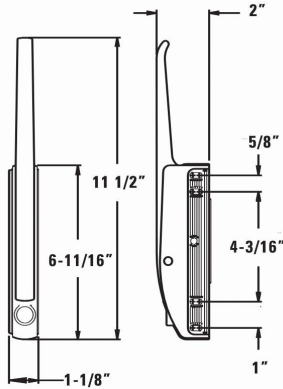

171 STRAIGHT DIE-CAST OR COMPOSITE HANDLE

SKU	Description
75-0034	Magnetic Cylinder Locking Latch
75-0073	Straight Die-Cast Latch
75-0217	Cylinder Lock Keys, #1311
75-0218	Cylinder Lock Keys, #1312
75-0219	Cylinder Lock Keys, #1313
75-0220	Cylinder Lock Keys, #1314
75-0221	Cylinder Lock Keys, #1315
75-0038	Cylinder Locking Kit #1311
75-0222	Cylinder Locking Kit #1312
75-0223	Cylinder Locking Kit #1313
75-0224	Cylinder Locking Kit #1314
75-0225	Cylinder Locking Kit #1315

0172 Mechanical Latch

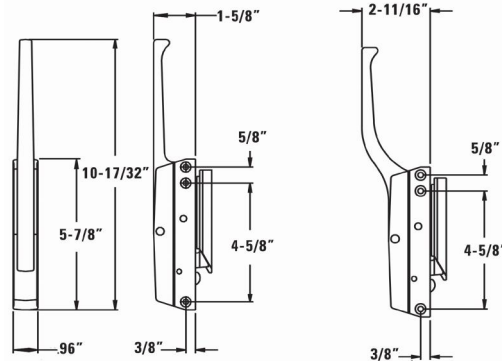

172 STRAIGHT

172B OFFSET

SKU	Description
75-0074	Straight Handle
75-0039	Offset Handle
75-0040	Offset Handle and Cylinder Lock
75-0075	Straight Handle and Cylinder Lock
75-0226	Cylinder Kit

KASON HARDWARE

0067 Shelf Support



SKU	Description
75-0245	Shelf Support, Kasonized Steel

99 Drop Shelf Bracket



SKU	Description
75-0246	Drop Shelf Bracket

7319 Stainless Skate Wheel with Countersunk Hole

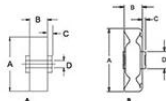

SKU	Description
75-0098	Stainless Skate Wheel with Countersunk Hole

0573 Offset Chrome Pull Handle



SKU	Description
75-0234	Offset Chrome Pull Handle

0574 Die Cast Pull Handle



SKU	Description
75-0033	Die Cast Pull Handle

Roller Grip Latch



SKU	Description
75-0235	Roller Grip Latch with Light Spring
75-0041	Roller Grip Latch with Heavy Spring

3700 Series Silicone Caulk



SKU	Description
75-0001	Aluminum
75-0002	Black
75-0003	Clear
75-0004	White



3701 Non-Skinning Butyl Sealant



SKU	Description
75-0005	Non-Skinning Butyl Sealant

*available in white or gray



7011 Series Trapper Grease Filter, Baffle



SKU	Description
75-0030	20" x 20" Grease Filter, Baffle
75-0031	16" x 20" Grease Filter, Baffle
75-0032	16" x 25" Grease Filter, Baffle

DOOR SWEEPS & HARDWARE

0066 Shelf Support

KASON



SKU	Description
75-0244	Shelf Support, Kasonized Steel
75-0099	Shelf Support, Stainless Steel

0520 Convex Roller

KASON



SKU	Description
75-0029	Convex Roller

Stainless Drill Bits

KASON

SKU	Description
75-0237	7/64" Drill Bit
75-0097	1/8" drill bit- pack of 3
75-0096	3/16" drill bit- pack of 3
75-0130	#30 Stub Length
75-0131	9/64" Stub Length
75-0251	5/32" Stub Length
75-0132	1/4" Stub Length
75-0239	3/8" Stub Length
75-0239	5/16" Stub Length
75-0240	1/2" Stub Length



Generic Door Sweeps



SKU	Description
74-0015	36" x 2"
74-0016	48" x 2"

Bulk Rubber Sweep Material



SKU	Description
74-0020	3" x 1/16" Rubber Sweep
74-0021	4" x 1/16" Rubber Sweep
74-0022	6" x 1/16" Rubber Sweep

Door Sweep

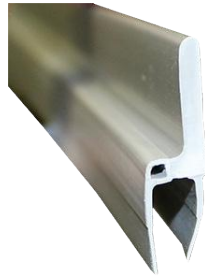

SKU	Length
74-0094	39"

*Commonly Fits Kolpak/Vollrath

Door Sweep

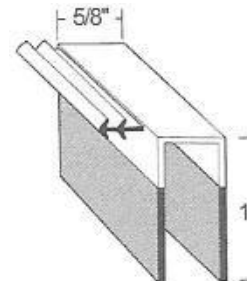

SKU	Description
74-0257	8' Stick

Generic Foam Gaskets

SKU	Description
74-0017	3/8" x 3/4" Foam Adhesive Gasket
74-0018	3/8" x 1" Foam Gasket Material
74-0019	3/8" x 1 1/4" Foam Gasket Material



STRIP CURTAINS

Quick Mount Plastic Strip Curtain Bracket

*Mounts to Wall or Ceiling



SKU	Description
74-0044	2' Plastic Mounting Bracket

*2" Spaced Mounting Hooks

Wall Mount Metal Strip Curtain Brackets



SKU	Description
74-0046	Metal 3' Bracket
74-0047	Metal 4' Bracket
74-0048	Metal 5' Bracket

*2" Spaced Threaded Studs

Universal Strip Curtain Brackets



SKU	Description
74-0260	3' Metal Bracket
74-0261	4' Metal Bracket
74-0263	5' Metal Bracket

*2" Spaced Threaded Studs

Orange Safety Replacement Strip



SKU	Width	Description
75-0189	8"	.06mil Cooler Grade

Black Replacement Strip



SKU	Width	Description
75-0183	8"	.08mil Cooler Grade

Ribbed Freezer Replacement Strip



SKU	Description
75-0188	8" Width .072mil
75-0187	12" Width .11mil

Cooler Replacement Strip



SKU	Description
75-0178	4" Width .06mil
75-0192	6" Width .06mil
75-0179	8" Width .08mil
75-0180	12" Width .12mil

Freezer Replacement Strip



SKU	Description
75-0184	4" Width .06mil
75-0185	6" Width .06mil
75-0186	8" Width .08mil
75-0113	12" Width .12mil

Ribbed Cooler Replacement Strip

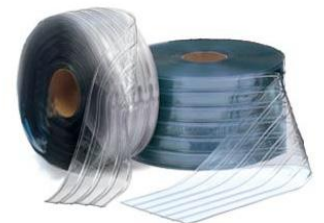

SKU	Description
75-0181	8" Width .072mil
75-0182	12" Width .11mil

KASON STRIP CURTAINS

Custom Strip Curtain Kits

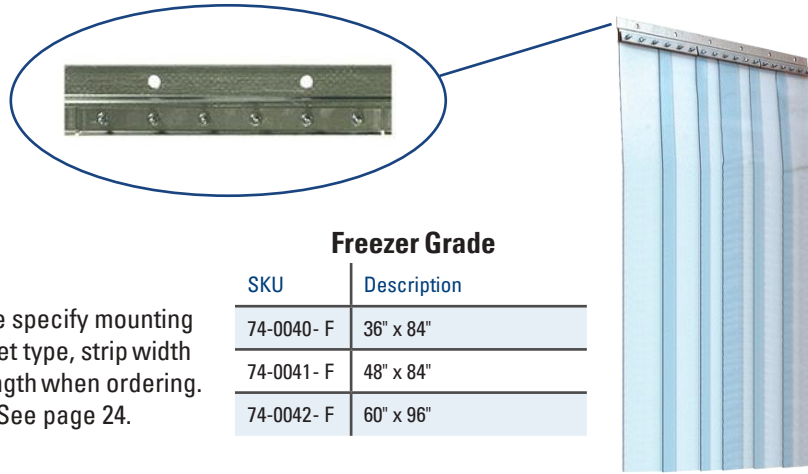

Cooler Grade

SKU	Description
74-0040- C	36" x 84"
74-0041- C	48" x 84"
74-0042- C	60" x 96"

Please specify mounting bracket type, strip width and length when ordering. See page 24.

Freezer Grade

SKU	Description
74-0040- F	36" x 84"
74-0041- F	48" x 84"
74-0042- F	60" x 96"

0401 Easimount Cooler-Rated Strip Curtain Kit



SKU	Description
75-0192	Easimount Strip Curtain Kit, Cooler Rated, Flush Wall, .06" Thick, 4" Wide, 50% Overlap, 34" x 84"
75-0193	Easimount Strip Curtain Kit, Cooler Rated, Flush Wall, .06" Thick, 6" Wide, 50% Overlap, 38" x 81"
75-0194	Easimount Strip Curtain Kit, Cooler Rated, Flush Wall, .06" Thick, 6" Wide, 50% Overlap, 38" x 84"
75-0195	Easimount Strip Curtain Kit, Cooler Rated, Flush Wall, .06" Thick, 6" Wide, 50% Overlap, 42" x 84"
75-0196	Easimount Strip Curtain Kit, Cooler Rated, Flush Wall, .08" Thick, 8" Wide, 50% Overlap, 84" In Length- Set of 6
75-0197	Easimount Strip Curtain Kit, Cooler Rated, Flush Wall, .06" Thick, 6" Wide, 50% Overlap, 84" In Length- Set of 6



0402 Easimount Freezer-Rated Strip Curtain Kit



SKU	Description
75-0094	Easimount 6" Wide Freezer Rated Replacement Strips- Set of 6- 6" Wide x 84" Long- 50% Overlap
75-0093	Easimount Strip Curtain Kit, Freezer Rated, Flush Wall, .06" Thick, 6" Wide, 50% Overlap, 38" x 84"
75-0198	Easimount Strip Curtain Kit, Freezer Rated, Flush Wall, .06" Thick, 6" Wide, 50% Overlap, 42" x 84"

0400 Easimount Mounting Bar

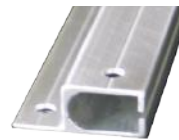

SKU	Description	Finish
75-0058	2 ft Mounting Bar	Aluminum
75-0059	3 ft Mounting Bar	Aluminum
75-0060	4 ft Mounting Bar	Aluminum
75-0061	5 ft Mounting Bar	Aluminum
75-0062	6 ft Mounting Bar	Aluminum
75-0063	7 ft Mounting Bar	Aluminum
75-0064	8 ft Mounting Bar	Aluminum
75-0190	Easimount Cover	Aluminum
75-0191	Easimount Cleat	Aluminum

***PRO TIP: 25% Overlap is most common.**

KASON STRIP CURTAINS

Easimount Clear Cooler Replacement Strip



SKU	Description
75-0192	6" Cooler Replacement Strip
75-0179	8" Cooler Replacement Strip

Easimount Clear Freezer Replacement Strip

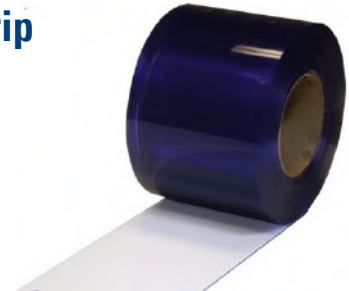

SKU	Description
75-0185	6" Freezer Replacement Strip
75-0186	8" Freezer Replacement Strip

Black Replacement Strip



SKU	Width	Description
75-0183	8"	Cooler Grade

Easimount Ribbed Cooler Replacement Strip



SKU	Description
75-0181	8" Ribbed Cooler Replacement Strip
75-0182	12" Ribbed Cooler Replacement Strip

Orange Safety Replacement Strip



SKU	Width	Description
75-0189	8"	Cooler Grade

CUSTOM DART GASKETS

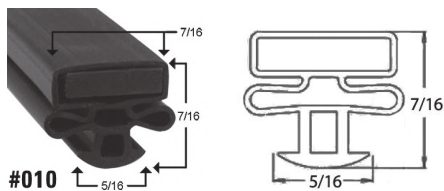

#010



#015

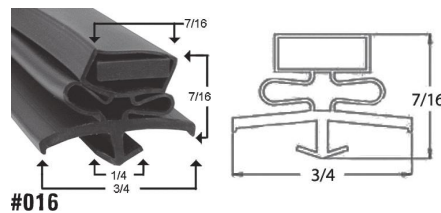

#016

Gasket

Commonly Fits: Leer, Hussmann, Anthony, Tyler

SKU	Product	Description
00-0010	Custom Size	Order by SKU & Outside Edge Dimensions
96-0010	8' Stick	Comes with Magnet

Gasket

Commonly Fits: Beverage Air, True

SKU	Product	Description
00-0015	Custom Size	Order by SKU & Outside Edge Dimensions
96-0015	8' Stick	Comes with Magnet

Gasket

Commonly Fits: Beverage Air, True

SKU	Product	Description
00-0016	Custom Size	Order by SKU & Outside Edge Dimensions
96-0016	8' Stick	Comes with Magnet

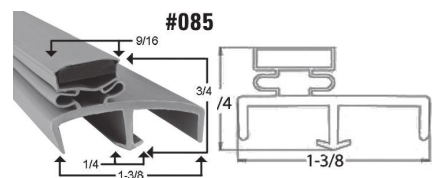

#085



#090

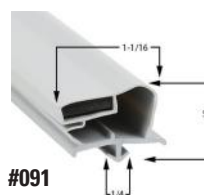

#091

Gasket

Commonly Fits: Victory

SKU	Product	Description
00-0085	Custom Size	Order by SKU & Outside Edge Dimensions
96-0085	8' Stick	Comes with Magnet

Gasket

Commonly Fits: Beverage Air

SKU	Product	Description
00-0090	Custom Size	Order by SKU & Outside Edge Dimensions
96-0090	8' Stick	Comes with Magnet

Gasket

Commonly Fits: Beverage Air

SKU	Product	Description
00-0091	Custom Size	Order by SKU & Outside Edge Dimensions
96-0091	8' Stick	Comes with Magnet

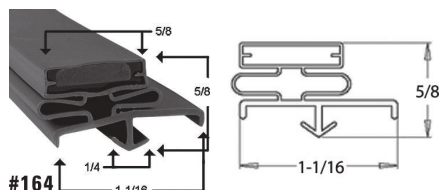

#164

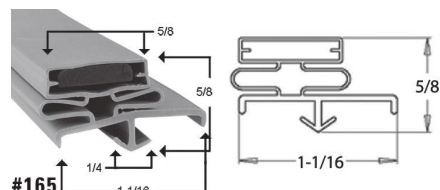

#165

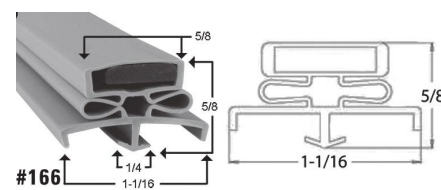

#166

Gasket

Commonly Fits: Traulsen, Beverage Air, Hobart, Norlake, McCall, Kolpak, Vollrath, Vulcan, Victory, Glenco, Leer

SKU	Product	Description
00-0164	Custom Size	Order by SKU & Outside Edge Dimensions
96-0164	8' Stick	Comes with Magnet

Gasket

Commonly Fits: Traulsen, Beverage Air, Hobart, Norlake, McCall, Kolpak, Vollrath, Vulcan, Victory, Glenco, Leer

SKU	Product	Description
00-0165	Custom Size	Order by SKU & Outside Edge Dimensions
96-0165	8' Stick	Comes with Magnet

Gasket

Commonly Fits: Traulsen, ColdTech, Continental, Manitowoc, Stanley Knight, Vulcan, Glenco, Victory

SKU	Product	Description
00-0166	Custom Size	Order by SKU & Outside Edge Dimensions
96-0166	8' Stick	Comes with Magnet

CUSTOM DART STYLE GASKETS

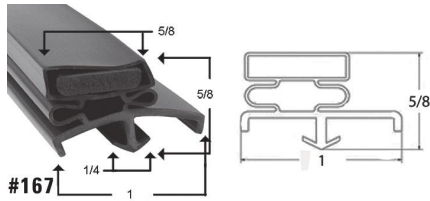

Gasket
Commonly Fits: Traulsen, Beverage Air, Hobart, Norlake, McCall, Kolpak, Vollrath, Vulcan, Victory, Glenco, Leer

SKU	Product	Description
00-0167	Custom Size	Order by SKU & Outside Edge Dimensions
96-0167	8' Stick	Comes with Magnet

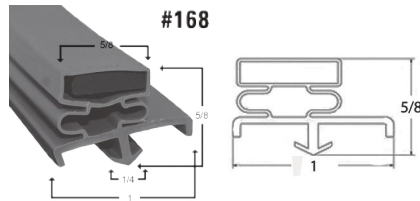

Gasket
Commonly Fits: Traulsen, Beverage Air, Hobart, Norlake, McCall, Kolpak, Vollrath, Vulcan, Victory, Glenco, Leer

SKU	Product	Description
00-0168	Custom Size	Order by SKU & Outside Edge Dimensions
96-0168	8' Stick	Comes with Magnet

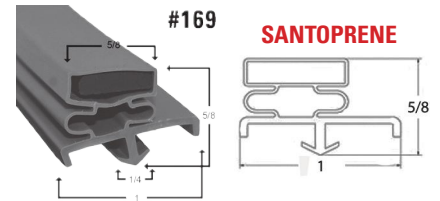

Gasket
Commonly Fits: Traulsen, Beverage Air, Hobart, Norlake, McCall, Kolpak, Vollrath, Vulcan, Victory, Glenco, Leer

SKU	Product	Description
00-0169	Custom Size	Order by SKU & Outside Edge Dimensions
96-0169	8' Stick	Comes with Magnet

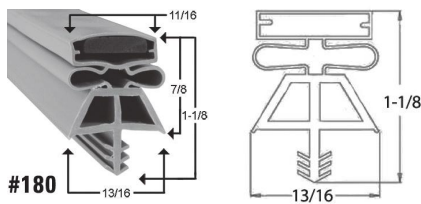

Gasket
Commonly Fits: Kolpak/Vollrath Walk-In's

SKU	Product	Description
00-0180	Custom Size	Order by SKU & Outside Edge Dimensions
96-0180	8' Stick	Comes with Magnet

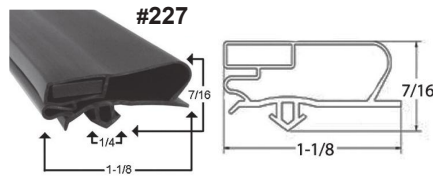

Gasket
Commonly Fits: Anthony, Zero-Zone

SKU	Product	Description
00-0227	Custom Size	Order by SKU & Outside Edge Dimensions
96-0227	8' Stick	Comes with Magnet

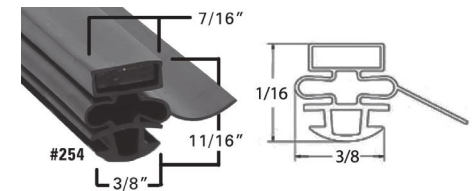

Gasket
Commonly Fits: Turbo Air, Beverage Air

SKU	Product	Description
00-0254	Custom Size	Order by SKU & Outside Edge Dimensions
96-0254	8' Stick	Comes with Magnet

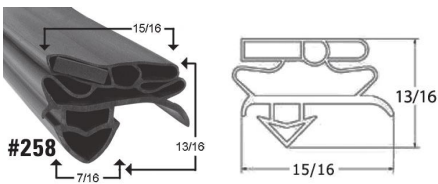

Gasket
Commonly Fits: True Mfg

SKU	Product	Description
00-0258	Custom Size	Order by SKU & Outside Edge Dimensions
96-0258	8' Stick	Comes with Magnet

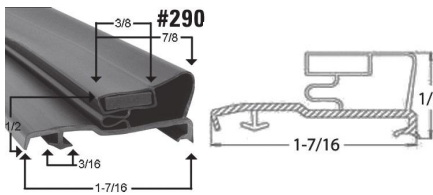

Gasket
Commonly Fits: Ardco, Pinnacle, Norlake, McCall, Hobart

SKU	Product	Description
00-0290	Custom Size	Order by SKU & Outside Edge Dimensions
96-0290	8' Stick	Comes with Magnet

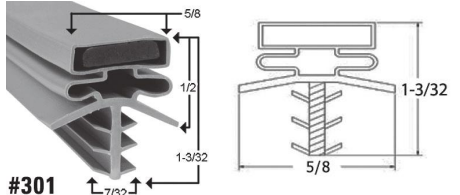

Gasket
Commonly Fits: Bally Walk-Ins, W.A. Brown

SKU	Product	Description
00-0301	Custom Size	Order by SKU & Outside Edge Dimensions
96-0301	8' Stick	Comes with Magnet

PRO TIP: Install **Dart Style Gaskets** by pushing in the corners first. Once the gasket is secured in the corners, push the center in and work towards the outside corners.

CUSTOM DART STYLE GASKETS



#301A

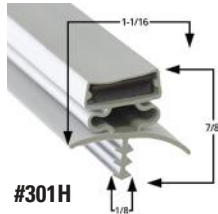

#301H

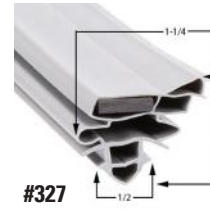

#327

Gasket

Commonly Fits: Brown Walk-Ins

SKU	Product	Description
00-0301A	Custom Size	Order by SKU & Outside Edge Dimensions
96-0301A	8' Stick	Comes with Magnet

Gasket

Commonly Fits: Brown Walk-Ins

SKU	Product	Description
00-0301H	Custom Size	Order by SKU & Outside Edge Dimensions
96-0301H	8' Stick	Comes with Magnet

Gasket

Commonly Fits: True

SKU	Product	Description
00-0327	Custom Size	Order by SKU & Outside Edge Dimensions
96-0327	8' Stick	Comes with Magnet

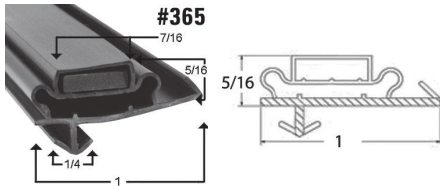

#365



#377

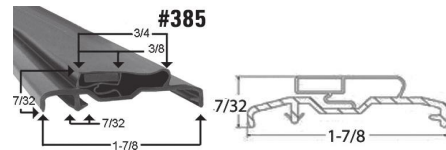

#385

Gasket

Commonly Fits: Anthony

SKU	Product	Description
00-0365	Custom Size	Order by SKU & Outside Edge Dimensions
96-0365	8' Stick	Comes with Magnet

Gasket

Commonly Fits: Schott Gemtron, Turbo Air

SKU	Product	Description
00-0377	Custom Size	Order by SKU & Outside Edge Dimensions
96-0377	8' Stick	Comes with Magnet

Gasket

Commonly Fits: Ardco

SKU	Product	Description
00-0385	Custom Size	Order by SKU & Outside Edge Dimensions
96-0385	8' Stick	Comes with Magnet

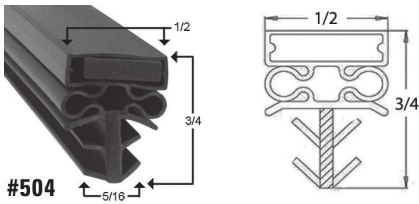

#504

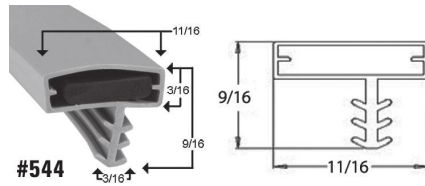

#544

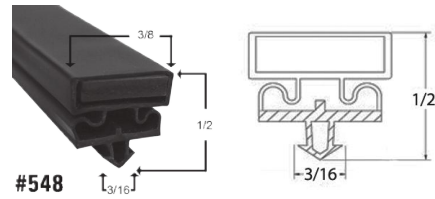

#548

Gasket

Commonly Fits: Howard, Traulsen, Barr, Schaefer

SKU	Product	Description
00-0504	Custom Size	Order by SKU & Outside Edge Dimensions
96-0504	8' Stick	Comes with Magnet

Gasket

Commonly Fits: Kolpak/Vollrath

SKU	Product	Description
00-0544	Custom Size	Order by SKU & Outside Edge Dimensions
96-0544	8' Stick	Comes with Magnet

Gasket

Commonly Fits: Styleline, Delfield, Victory

SKU	Product	Description
00-0548	Custom Size	Order by SKU & Outside Edge Dimensions
96-0548	8' Stick	Comes with Magnet

CUSTOM DART STYLE GASKETS



#549

Gasket		
Commonly Fits: Styleline, Hussmann		
SKU	Product	Description
00-0549	Custom Size	Order by SKU & Outside Edge Dimensions
96-0549	8' Stick	Comes with Magnet



#551

Gasket		
Commonly Fits: Styleline		
SKU	Product	Description
00-0551	Custom Size	Order by SKU & Outside Edge Dimensions
96-0551	8' Stick	Comes with Magnet

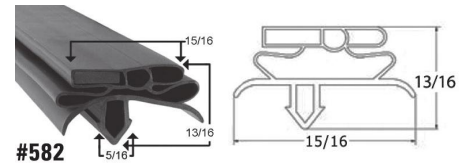

#582

Gasket		
Commonly Fits: True Mfg		
SKU	Product	Description
00-0582	Custom Size	Order by SKU & Outside Edge Dimensions
96-0582	8' Stick	Comes with Magnet



#599

Gasket		
Commonly Fits: Arctic Air, Entree, Saturn, Kelvinator, Icon, Avantco, Atosa		
SKU	Product	Description
00-0599	Custom Size	Order by SKU & Outside Edge Dimensions
96-0582	8' Stick	Comes with Magnet

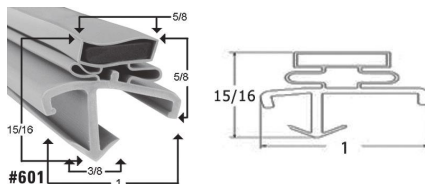

#601

Gasket		
Commonly Fits: American Panel		
SKU	Product	Description
00-0601	Custom Size	Order by SKU & Outside Edge Dimensions
96-0601	8' Stick	Comes with Magnet

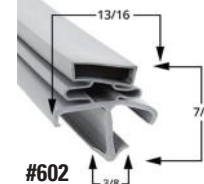

#602

Gasket		
Commonly Fits: American Panel		
SKU	Product	Description
00-0602	Custom Size	Order by SKU & Outside Edge Dimensions
96-0602	8' Stick	Comes with Magnet



#608

Gasket		
Commonly Fits: Traulsen		
SKU	Product	Description
00-0608	Custom Size	Order by SKU & Outside Edge Dimensions
96-0608	8' Stick	Comes with Magnet

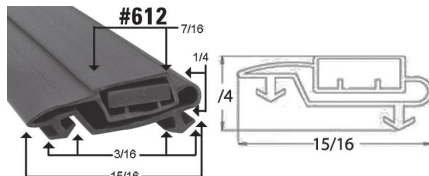

#612

Gasket		
Commonly Fits: Anthony		
SKU	Product	Description
00-0612	Custom Size	Order by SKU & Outside Edge Dimensions
96-0612	8' Stick	Comes with Magnet

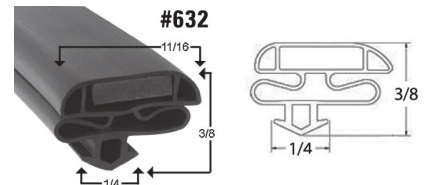

#632

Gasket		
Commonly Fits: Anthony, ColdTech, Howard McCray, Masterbilt		
SKU	Product	Description
00-0632	Custom Size	Order by SKU & Outside Edge Dimensions
96-0632	8' Stick	Comes with Magnet

PRO TIP: Install Dart Style Gaskets by pushing in the corners first. Once the gasket is secured in the corners, push the center in and work towards the outside corners.

CUSTOM DART STYLE GASKETS

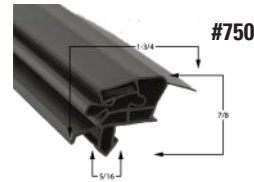
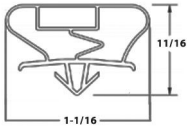
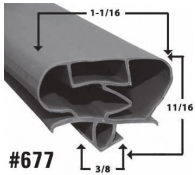

Gasket

Commonly Fits: Hoshizaki

SKU	Product	Description
00-0677	Custom Size	Order by SKU & Outside Edge Dimensions
96-0677	8' Stick	Comes with Magnet

Gasket

Commonly Fits: Turbo Air

SKU	Product	Description
00-0697	Custom Size	Order by SKU & Outside Edge Dimensions
96-0697	8' Stick	Comes with Magnet

Gasket

Commonly Fits: ColdTech

SKU	Product	Description
00-0750	Custom Size	Order by SKU & Outside Edge Dimensions
96-0750	8' Stick	Comes with Magnet

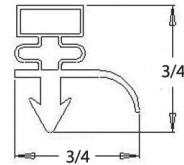
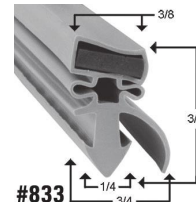
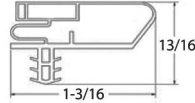
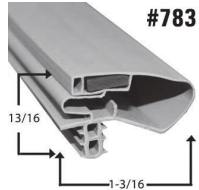
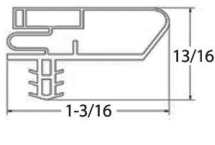
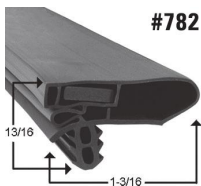

Gasket

Commonly Fits: Hussmann

SKU	Product	Description
00-0782	Custom Size	Order by SKU & Outside Edge Dimensions
96-0782	8' Stick	Comes with Magnet

Gasket

Commonly Fits: Hussmann

SKU	Product	Description
00-0783	Custom Size	Order by SKU & Outside Edge Dimensions
96-0783	8' Stick	Comes with Magnet

Gasket

Commonly Fits: Silver King

SKU	Product	Description
00-0833	Custom Size	Order by SKU & Outside Edge Dimensions
96-0833	8' Stick	Comes with Magnet

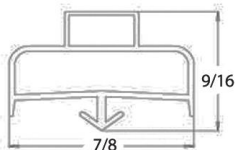
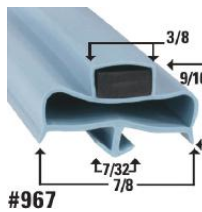
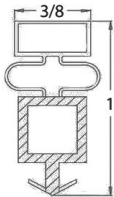
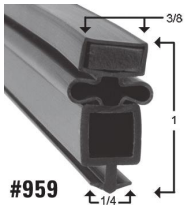

Gasket

Commonly Fits: True Mfg

SKU	Product	Description
00-0959	Custom Size	Order by SKU & Outside Edge Dimensions
96-0959	8' Stick	Comes with Magnet

Gasket

Commonly Fits: Delfield

SKU	Product	Description
00-0967	Custom Size	Order by SKU & Outside Edge Dimensions
96-0967	8' Stick	Comes with Magnet

PUSH-IN GASKETS

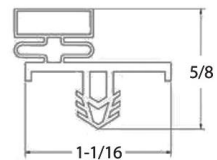
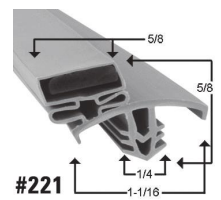

Gasket

Commonly Fits: Delfield

SKU	Product	Description
00-0221	Custom Size	Order by SKU & Outside Edge Dimensions
96-0221	8' Stick	Comes with Magnet

CUSTOM PUSH-IN GASKETS

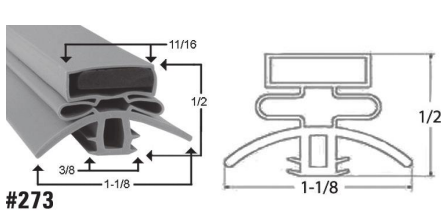

#273

Gasket
Commonly Fits: Hobart, Foster

SKU	Product	Description
00-0273	Custom Size	Order by SKU & Outside Edge Dimensions
96-0273	8' Stick	Comes with Magnet



#598

Gasket
Commonly Fits: Arctic Air, Entree, Saturn, Kelvinator, Icon, Avantco, Atosa

SKU	Product	Description
00-0598	Custom Size	Order by SKU & Outside Edge Dimensions
96-0582	8' Stick	Comes with Magnet

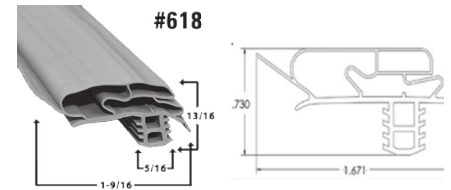

#618

Gasket
Commonly Fits: Delfield

SKU	Product	Description
00-0618	Custom Size	Order by SKU & Outside Edge Dimensions
96-0618	8' Stick	Comes with Magnet



#619

Gasket
Commonly Fits: Delfield

SKU	Product	Description
00-0619	Custom Size	Order by SKU & Outside Edge Dimensions
96-0619	8' Stick	Comes with Magnet

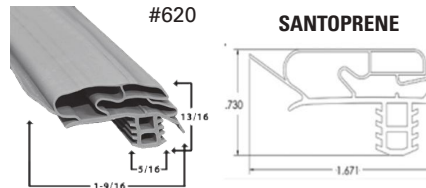

#620 SANTOPRENE

Gasket
Commonly Fits: Delfield

SKU	Product	Description
00-0620	Custom Size	Order by SKU & Outside Edge Dimensions
96-0620	8' Stick	Comes with Magnet

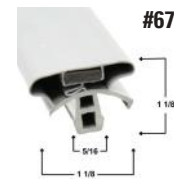

#678

Gasket
Commonly Fits: Hoshizaki

SKU	Product	Description
00-0678	Custom Size	Order by SKU & Outside Edge Dimensions
96-0678	8' Stick	Comes with Magnet

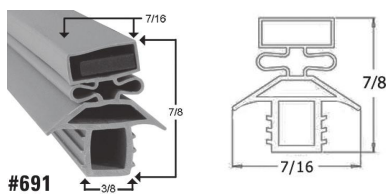

#691

Gasket
Commonly Fits: Traulsen

SKU	Product	Description
00-0691	Custom Size	Order by SKU & Outside Edge Dimensions
96-0691	8' Stick	Comes with Magnet

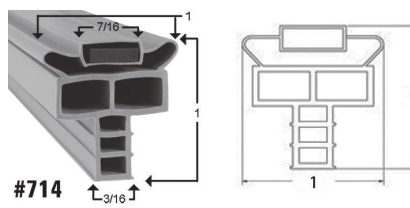

#714

Gasket
Commonly Fits: Randell

SKU	Product	Description
00-0714	Custom Size	Order by SKU & Outside Edge Dimensions
96-0714	8' Stick	Comes with Magnet

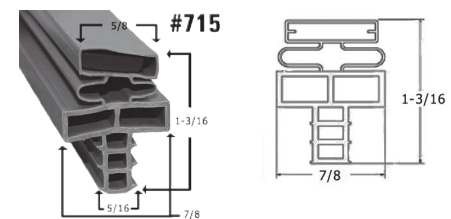

#715

Gasket
Commonly Fits: Randell

SKU	Product	Description
00-0715	Custom Size	Order by SKU & Outside Edge Dimensions
96-0715	8' Stick	Comes with Magnet

Custom Gaskets are Made From **Outside Edge to Outside Edge** Dimensions. **Please specify if you have dart to dart measurements.**

CUSTOM PUSH-IN GASKETS

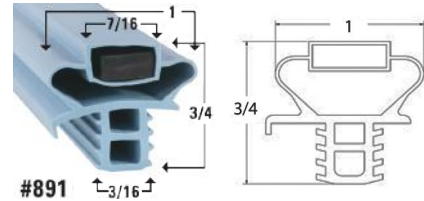
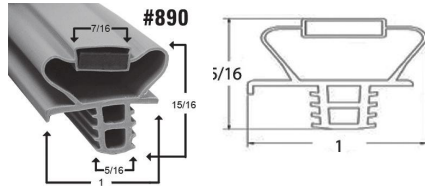
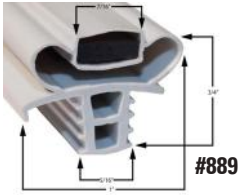

Gasket		
Commonly Fits: Delfield		
SKU	Product	Description
00-0889	Custom Size	Order by SKU & Outside Edge Dimensions
96-0889	8' Stick	Comes with Magnet

Gasket		
Commonly Fits: Delfield		
SKU	Product	Description
00-0890	Custom Size	Order by SKU & Outside Edge Dimensions
96-0890	8' Stick	Comes with Magnet

Gasket		
Commonly Fits: Delfield		
SKU	Product	Description
00-0891	Custom Size	Order by SKU & Outside Edge Dimensions
96-0891	8' Stick	Comes with Magnet

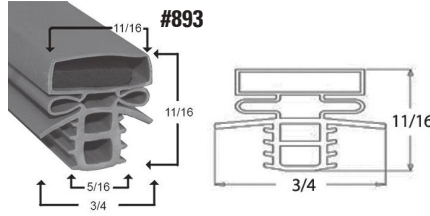
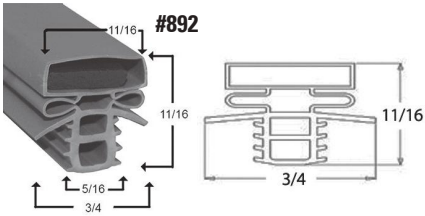

Gasket		
Commonly Fits: Delfield Randell		
SKU	Product	Description
00-0892	Custom Size	Order by SKU & Outside Edge Dimensions
96-0892	8' Stick	Comes with Magnet

Gasket		
Commonly Fits: Delfield, Randell		
SKU	Product	Description
00-0893	Custom Size	Order by SKU & Outside Edge Dimensions
96-0893	8' Stick	Comes with Magnet

Gasket		
Commonly Fits: Delfield, Randell		
SKU	Product	Description
00-0895	Custom Size	Order by SKU & Outside Edge Dimensions
96-0895	8' Stick	Comes with Magnet

CUSTOM COMPRESSION GASKETS

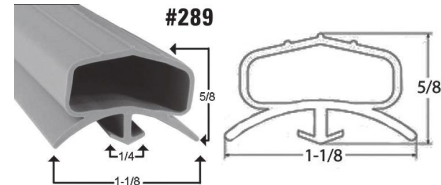
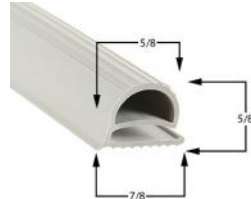
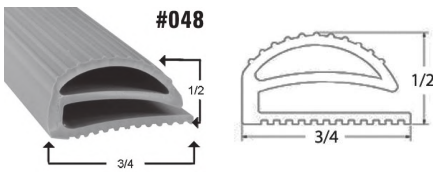

Gasket		
Commonly Fits: Screw InTracks		
SKU	Product	Description
00-0048	Custom Size	Order by SKU & Outside Edge Dimensions
96-0048	8' Stick	

Gasket		
Commonly Fits: Screw InTracks		
SKU	Product	Description
00-0049	Custom Size	Order by SKU & Outside Edge Dimensions
96-0049	8' Stick	

Gasket		
Commonly Fits: Glenco, Hobart, Silver King		
SKU	Product	Description
00-0289	Custom Size	Order by SKU & Outside Edge Dimensions
96-0289	8' Stick	

CUSTOM SCREW-IN GASKETS

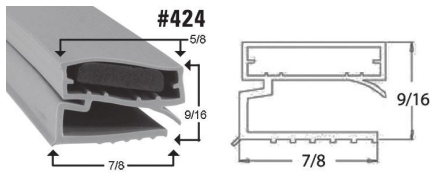

Gasket
Commonly Fits: Evans, Ever Frost, Federal, Traulsen, Carter Hoffman, Utility

SKU	Product	Description
00-0424	Custom Size	Order by SKU & Outside Edge Dimensions
96-0424	8' Stick	Comes with Magnet

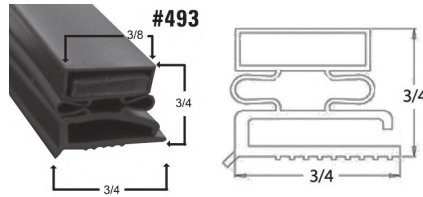

Gasket
Commonly Fits: Traulsen, Leer, Starrett, Norlake, Utility, Stanley Knight

SKU	Product	Description
00-0493	Custom Size	Order by SKU & Outside Edge Dimensions
96-0493	8' Stick	Comes with Magnet

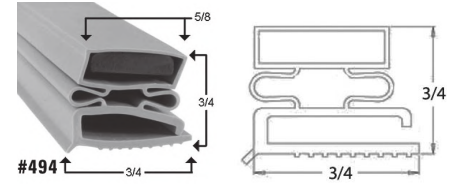

Gasket
Commonly Fits: Traulsen, Leer, Starrett, Norlake, Utility, Stanley Knight

SKU	Product	Description
00-0494	Custom Size	Order by SKU & Outside Edge Dimensions
96-0494	8' Stick	Comes with Magnet

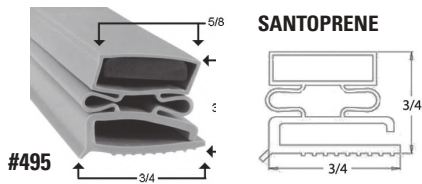

Gasket
Commonly Fits: Traulsen, Leer, Starrett, Norlake, Utility, Stanley Knight

SKU	Product	Description
00-0495	Custom Size	Order by SKU & Outside Edge Dimensions
96-0495	8' Stick	Comes with Magnet

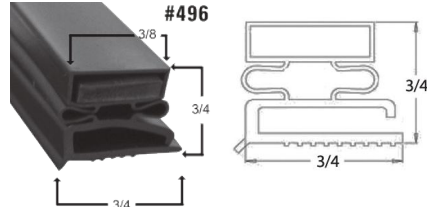

Gasket
Commonly Fits: Traulsen, Leer, Starrett, Norlake, Utility, Stanley Knight

SKU	Product	Description
00-0496	Custom Size	Order by SKU & Outside Edge Dimensions
96-0496	8' Stick	Comes with Magnet

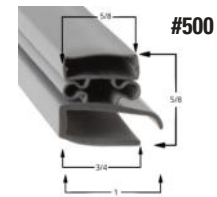

Gasket
Commonly Fits: Traulsen, La Rosa, Leer, Starrett, Norlake, Stanley Knight

SKU	Product	Description
00-0500	Custom Size	Order by SKU & Outside Edge Dimensions
96-0500	8' Stick	Comes with Magnet

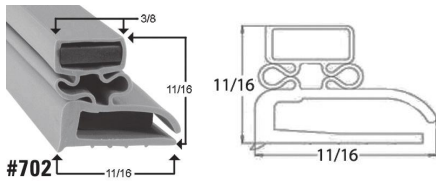

Gasket
Commonly Fits: Delfield, Hobart, Perlick, Howard/McCray, Jordon, Randell, Rhodes, Tyler

SKU	Product	Description
00-0702	Custom Size	Order by SKU & Outside Edge Dimensions
96-0702	8' Stick	Comes with Magnet

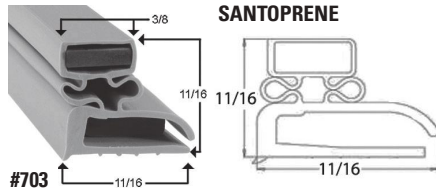

Gasket
Commonly Fits: Delfield, Hobart, Perlick, Howard/McCray, Jordon, Randell, Rhodes, Tyler

SKU	Product	Description
00-0703	Custom Size	Order by SKU & Outside Edge Dimensions
96-0703	8' Stick	Comes with Magnet

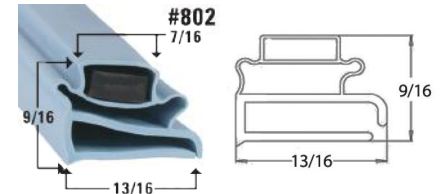

Gasket
Commonly Fits: Delfield

SKU	Product	Description
00-0802	Custom Size	Order by SKU & Outside Edge Dimensions
96-0802	8' Stick	Comes with Magnet

RETAINER STYLE GASKETS

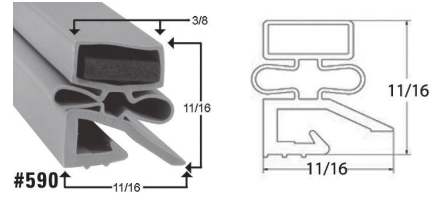
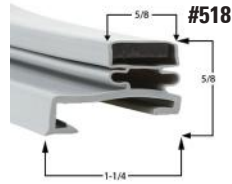

Gasket
Commonly Fits: Traulsen, La Rosa, Leer, Starrett, Nor-Lake, Stanley Knight

SKU	Product	Description
00-0500	Custom Size	Order by SKU & Outside Edge Dimensions
96-0500	8' Stick	Comes with Magnet

Gasket
Commonly Fits: Victory

SKU	Product	Description
00-0518	Custom Size	Order by SKU & Outside Edge Dimensions
96-0518	8' Stick	Comes with Magnet

Gasket
Commonly Fits: Hobart, Utility, Vulcan

SKU	Product	Description
00-0590	Custom Size	Order by SKU & Outside Edge Dimensions
96-0590	8' Stick	Comes with Magnet

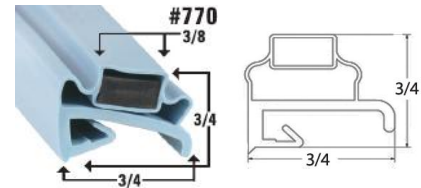
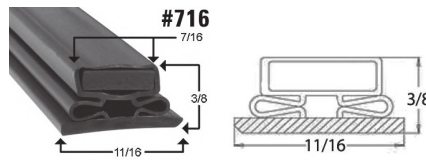
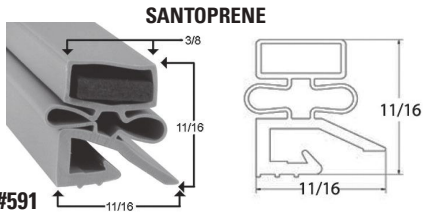

Gasket
Commonly Fits: Hobart, Utility, Vulcan

SKU	Product	Description
00-0591	Custom Size	Order by SKU & Outside Edge Dimensions
96-0591	8' Stick	Comes with Magnet

Gasket
Commonly Fits: Ardco, Barr, LaCrosse, Puffer Hubbard

SKU	Product	Description
00-0716	Custom Size	Order by SKU & Outside Edge Dimensions
96-0716	8' Stick	Comes with Magnet

Gasket
Commonly Fits: Delfield

SKU	Product	Description
00-0770	Custom Size	Order by SKU & Outside Edge Dimensions
96-0770	8' Stick	Comes with Magnet

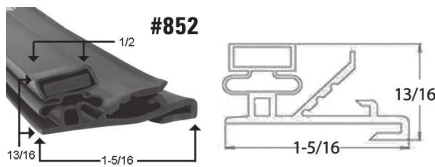

Gasket
Commonly Fits: Styleline, Leer, McCall, Victory, Zero Zone

SKU	Product	Description
00-0852	Custom Size	Order by SKU & Outside Edge Dimensions
96-0852	8' Stick	Comes with Magnet

SANTOPRENE GASKETS

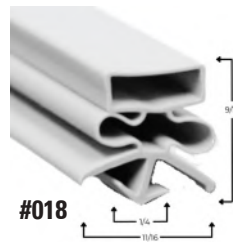

Gasket
Commonly Fits: Metro

SKU	Product	Description
00-0018	Custom Size	Order by SKU & Outside Edge Dimensions
96-0018	8' Stick	Comes with Magnet

*See our Retainers on pg. 97

CUSTOM SANTOPRENE GASKETS



Gasket
Commonly Fits: Generic Compression Gasket

SKU	Product	Description
00-0050	Custom Size	Order by SKU & Outside Edge Dimensions
96-0050	8' Stick	

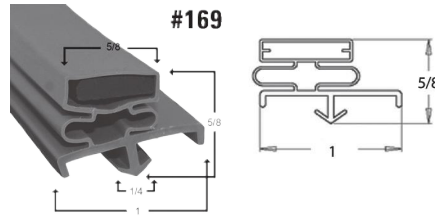

Gasket
Commonly Fits: Delfield, Hobart, Howard, Jordon, Randell, Rhodes

SKU	Product	Description
00-0169	Custom Size	Order by SKU & Outside Edge Dimensions
96-0169	8' Stick	Comes with Magnet

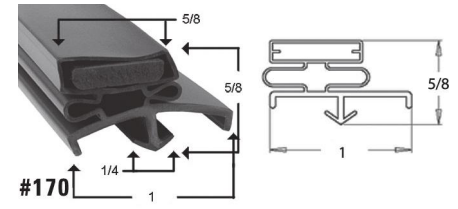

Gasket
Commonly Fits: Delfield, Hobart, Howard, Jordon, Randell, Rhodes

SKU	Product	Description
00-0170	Custom Size	Order by SKU & Outside Edge Dimensions
96-0170	8' Stick	Comes with Magnet

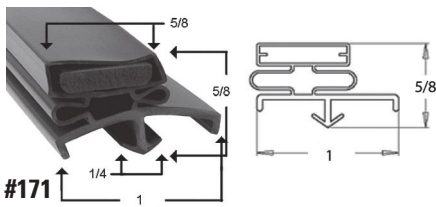

Gasket
Commonly Fits: Delfield, Hobart, Howard, Jordon, Randell, Rhodes

SKU	Product	Description
00-0171	Custom Size	Order by SKU & Outside Edge Dimensions
96-0171	8' Stick	Comes with Magnet

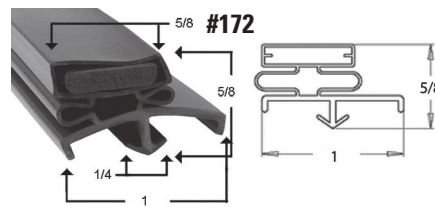

Gasket
Commonly Fits: Delfield, Hobart, Howard, Jordon, Randell, Rhodes

SKU	Product	Description
00-0172	Custom Size	Order by SKU & Outside Edge Dimensions
96-0172	8' Stick	Comes with Magnet

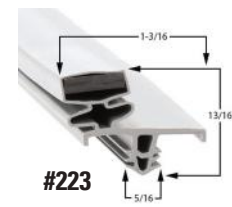

Gasket
Commonly Fits: Delfield

SKU	Product	Description
00-0223	Custom Size	Order by SKU & Outside Edge Dimensions
96-0223	8' Stick	Comes with Magnet



Gasket
Commonly Fits: Delfield

SKU	Product	Description
00-0229	Custom Size	Order by SKU & Outside Edge Dimensions
96-0229	8' Stick	Comes with Magnet

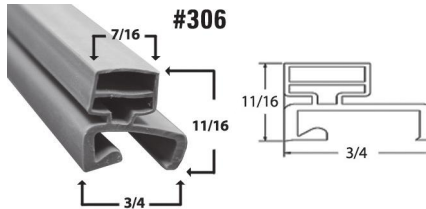

Gasket
Commonly Fits: Henny Penny

SKU	Product	Description
00-0306	Custom Size	Order by SKU & Outside Edge Dimensions
96-0306	8' Stick	Comes with Magnet

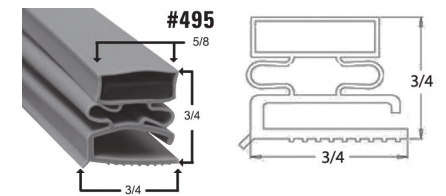

Gasket
Commonly Fits: Traulsen, Leer, Starret, Norlake, Utility, Stanley Knight

SKU	Product	Description
00-0495	Custom Size	Order by SKU & Outside Edge Dimensions
96-0495	8' Stick	Comes with Magnet

CUSTOM SANTOPRENE GASKETS

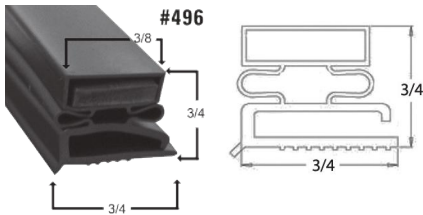

Gasket
Commonly Fits: Traulsen, Leer, Starret, Norlake, Utility, Stanley Knight

SKU	Product	Description
00-0496	Custom Size	Order by SKU & Outside Edge Dimensions
96-0496	8' Stick	Comes with Magnet

Gasket
Commonly Fits: Styleline, Delfield, Victory (Glass Doors)

SKU	Product	Description
00-0550	Custom Size	Order by SKU & Outside Edge Dimensions
96-0550	8' Stick	Comes with Magnet

Gasket
Commonly Fits: Traulsen (Easy Clean)

SKU	Product	Description
00-0577	Custom Size	Order by SKU & Outside Edge Dimensions
96-0577	8' Stick	Comes with Magnet

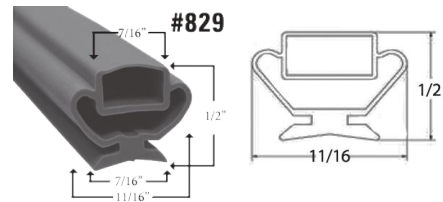

Gasket
Commonly Fits: Traulsen

SKU	Product	Description
00-0608	Custom Size	Order by SKU & Outside Edge Dimensions
96-0608	8' Stick	Comes with Magnet

Gasket
Commonly Fits: Duke, NuVu

SKU	Product	Description
00-0738	Custom Size	Order by SKU & Outside Edge Dimensions
96-0738	8' Stick	Comes with Magnet

Gasket
Commonly Fits: Bevels

SKU	Product	Description
00-0829	Custom Size	Order by SKU & Outside Edge Dimensions
96-0829	8' Stick	Comes with Magnet

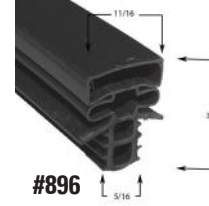
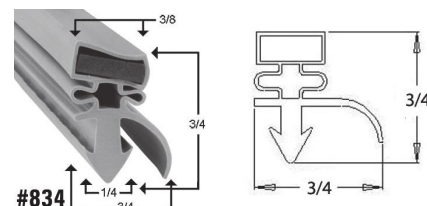

Gasket
Commonly Fits: Silver King

SKU	Product	Description
00-0829	Custom Size	Order by SKU & Outside Edge Dimensions
96-0829	8' Stick	Comes with Magnet

Gasket
Commonly Fits: Silver King

SKU	Product	Description
00-0834	Custom Size	Order by SKU & Outside Edge Dimensions
96-0834	8' Stick	Comes with Magnet

Gasket
Commonly Fits: Delfield, Randell

SKU	Product	Description
00-0896	Custom Size	Order by SKU & Outside Edge Dimensions
96-0896	8' Stick	Comes with Magnet

GASKETS BY BRAND

Welcome to our manufacturer section. We are proud to offer OEM quality refrigeration gaskets and hardware. Please note that these products are in stock, unless otherwise noted and are made to brand-specific size. Additional sizes are available. If you do not see the size you need call us!

Measuring Instructions

All measurements are noted as outside edge to outside edge dimensions. Please follow the instructions below to properly measure your gasket:

1. Take a look at the gasket currently on the door and match the style up to one of the profiles in the catalog. If you do not see the exact style, call us and we'll help find the correct profile.
2. Using a tape measure, measure the outside edge width of the gasket that is currently on the door. Start by measuring from outside right side to outside left side of the gasket. Note the size to the closest 1/8". Now measure the height of the gasket from bottom to the top of the gasket and note the size. Measuring the outside edge dimension properly is critical for the replacement gasket to fit properly. If the gasket seems to be stretched or warped a bit, don't worry, as long as you are within 1/8 inch, the replacement gasket should install properly. Use your best judgment from looking at how the gasket is sitting on the door to understand if the measurement you made is going to be accurate.
3. Look at the entire perimeter of the gasket and determine if the gasket is a full 4 sided gasket, or if it only needs to have 2 or 3 sides. Most refrigeration door gaskets are 4 sided, but when you are working with large walk in cooler doors, you will find many of those are 3 sided gaskets with no bottom. Also, over time, you will end up doing estimates in kitchens with specialty equipment and you will come across situations where the gaskets are not 4 sided. If the gasket is NOT 4 sided, then you will need to specify which sides you would like us to include.

Products By Brand

Alta-Shaam	35	Masterbilt	60
Anthony	35	McCall	62
Arctic	40	Nor-Lake	63
Ardco	40	Perlick	65
Bally	42	Randell	65
Beverage-Air	43	Schott Gemtron	68
Brown	45	Silver King	72
Continental	46	Styleline	73
Delfield	47	Thermo-Kool	75
Florida Stainless	53	Traulsen	75
Glastender	53	True Manufacturing	79
Hobart	54	Turbo Air	81
Hoshizaki	55	Victory	82
Kairak	55	Vollrath	84
Kelvinator	56	W.A. Brown	85
Kolpak	56	Wasserstrom	86
La Rosa	58	Zero Zone	86
Leer	59		

ALTO-SHAAM

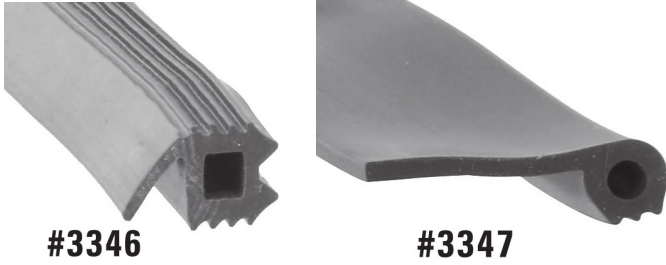

#3346

#3347

Hot Side Gasket

SKU	Dimensions (Inches)	OEM #
79-0001	19 1/2 x 28 1/2	GS-23794
79-0002	21 1/2 x 23	GS-22951
79-0003	22 x 30 1/2	GS-23796

Both profiles can be ordered in custom sizes by the foot.

ALTO-SHAAM

ANTHONY

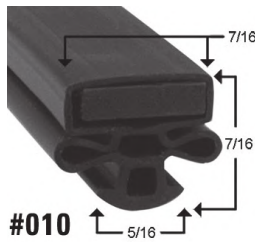

#010

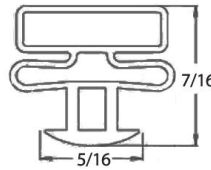

Most Popular Sizes

ANTHONY

Dart Style Magnetic

SKU	Dim. (Inches)	Commonly Fits Models	SKU	Dim. (Inches)	Commonly Fits Models	SKU	Dim. (Inches)	Commonly Fits Models
03-0031	22 3/4 x 62 3/4	6000 AOM	03-0033	24 3/4 x 63	6000 AOM	03-0030	29 7/8 x 71 1/16	6000 AOM
03-0025	23 3/16 x 34 1/16	6000 AOM	03-0003	28 x 61 5/8	TSSU/TUC/TWT-48	03-0022	30 x 36	100/100R
03-0026	23 3/16 x 65 1/16	6000 AOM	03-0004	28 1/4 x 62 1/2		03-0023	30 x 67	100/100R
03-0027	23 3/16 x 71 1/16	6000 AOM	03-0032	28 3/4 x 63	6000 AOM	03-0024	30 x 73	100/100R
03-0019	24 x 36	100/100R	03-0035	29 1/4 x 60 1/4		03-0002	31 3/4 x 59 1/2	
03-0020	24 x 67	100/100R	03-0036	29 1/4 x 64 1/4		03-0005	31 3/4 x 62 1/2	
03-0021	24 x 73	100/100R	03-0028	29 7/8 x 34 1/16	6000 AOM	03-0034	38 1/2 x 62 1/2	6000 AOM
03-0001	24 1/4 x 59 3/4		03-0029	29 7/8 x 65 1/16	6000 AOM			



PRO Tip

Have the Anthony door dimensions and the gasket profile? **We can make it!**

ANTHONY

ANTHONY

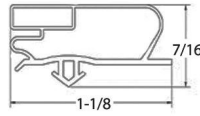

Most Popular Sizes

Aircell Starting After 1998

Door Mounted Dart Style by Door Dimension

SKU	Door Dim. (Inches)	OEM Part #	SKU	Door Dim (Inches)	OEM Part #	SKU	Door Dim (Inches)	OEM Part #
03-0138	21 5/8 x 64 7/8	02--16199--0003	03-0111**	28 3/4 x 62 1/8		03-0115**	29 5/8 x 65	
03-0041	22 11/16 x 60 3/16	02--14160--2001	03-0059	28 3/8 x 71 1/16	02--14160--2025	03-0154	29 13/16 x 70 3/16	
03-0103**	23 x 53 5/8		03-0056	28 3/8 x 73 1/16	02--14160--2022	03-0043	29 7/8 x 60 11/16	02--14160--2004
03-0149	23 1/16 x 55 1/2		03-0060	28 3/8 x 77 1/16	02--14160--2026	03-0047	29 7/8 x 62 13/16	02--14160--2009
03-0105	23 1/8 x 27 3/16	02--14160--2002	03-0110**	28 3/8 x 77 1/8		03-0044	29 7/8 x 63 3/8	02--14160--2006
03-0150	23 1/8 x 55 7/16		03-0063	28 7/8 x 76 7/8	02--14160--2029	03-0045	29 7/8 x 65	02--14160--2007
03-0104**	23 1/4 x 65 1/4		03-0118***	28 7/8 x 78 3/4		03-0144	29 7/8 x 65 1/16	02--14160--2036
03-0065	23 13/16 x 36 9/16	02--14160--2031	03-0037	29 1/16 x 62 9/16	02--14160--2018	03-0155	29 7/8 x 66 9/16	
03-0066	23 13/16 x 44 7/16	02--14160--2032	03-0075	29 1/16 x 66 9/16	02--14160--2042	03-0064	29 7/8 x 67 15/16	02--14160--2030
03-0042	23 3/16 x 54 1/16	02--14160--2003	03-0203	29 1/16 x 71 1/16	02--14160--2066	03-0135	29 7/8 x 71 1/16	02--14160--2027
03-0071	23 3/16 x 62 13/16	02--14160--2038	03-0113**	29 1/2 x 62 1/2		03-0204	29 7/8 x 2	02--14160--2045
03-0143	23 3/16 x 65 1/16	02--14160--2010	03-0114**	29 1/2 x 64 3/4		03-0046	29 7/8 x 73 1/16	02--14160--2008
03-0050	23 3/16 x 73 1/16	02--14160--2013	03-0116**	29 1/2 x 73		03-0057	29 7/8 x 77 1/16	02--14160--2023
03-0151	23 5/8 x 38 1/4		03-0074	29 3/16 x 60 1/8	02--14160--2041	03-0072	29 7/8 x 79 1/16	02--14160--2039
03-0062	23 3/4 x 61 1/4	02--14160--2028	03-0049	29 3/16 x 60 3/16	02--14160--2011	03-0067	30 7/8 x 69 1/16	02--14160--2033
03-0107**	26 1/2 x 65 1/4		03-0038	29 3/16 x 62 9/16	02--14160--2012	03-0039	32 1/2 x 62 13/16	02--14160--2014
03-0108**	26 1/4 x 73		03-0073	29 3/16 x 65 1/16	02--14160--2040	03-0156	33 1/16 x 61 1/8	
03-0058	26 3/8 x 65 1/16	02--14160--2024	03-0051	29 3/16 x 65 1/16	02--14160--2015	03-0076	35 1/16 x 62 9/16	02--14160--2062
03-0053	26 3/8 x 71 1/16	02--14160--2017	03-0052	29 3/16 x 66 9/16	02--14160--2016	03-0157	35 1/16 x 66 9/16	
03-0055	26 3/8 x 73 1/16	02--14160--2021	03-0152	29 3/8 x 64 5/8		03-0070	35 7/16 x 79 1/16	02--14160--2037
03-0106**	26 x 70 3/4		03-0054	29 3/4 x 65 1/16	02--14160--2020	03-0130***	35 7/16 x 79 1/16	
03-0152	26 3/8 x 37 1/4	02--14160--2035	03-0117**	29 3/4 x 77 1/2		03-0158	35 11/16 x 77 7/8	
03-0153	27 15/16 x 69 1/16	02--14160--2043	03-0112**	29 3/8 x 60 3/8		03-0119***	35 x 78 7/8	
03-0068	27 15/16 x 69 1/16	02--14160--2034						
03-0109**	28 1/4 x 73							

*3 sides
 **OD Gasket Dimensions
 ***3 sides, OD Gasket Dimensions



PRO Tip

Gaskets for Anthony doors are narrower and shorter than the door size.

Gasket Retainer

SKU	Dimensions (Inches)
96-0225	8' Stick



*For use with #226 Door Mounted Dart Style **#225**

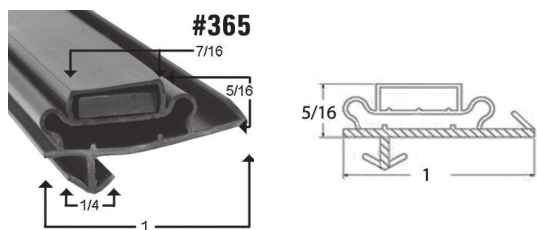

Model 1000 on Equipment Made After November 1981

Don't See the Size You Need? Check Out Our Custom Gasket Section on page 64!

Frame Mounted Dart Style					
SKU	Dimensions (Inches)	OEM Part #	SKU	Dimensions (Inches)	OEM Part #
03-0159	21 5/8 x 64	02--10090--0001	03-0162	27 3/8 x 72	02--10090--0008
03-0160	21 5/8 x 70	02--10090--0002	03-0017	28 3/4 x 33	
03-0161	21 5/8 x 72	02--10090--0003	03-0012	28 3/4 x 64	
03-0014	21 3/4 x 34 1/2		03-0011	28 3/4 x 70	
03-0007	21 3/4 x 50 3/4		03-0163	28 3/4 x 73	02--10090--0007
03-0008	21 3/4 x 64		03-0013	28 3/4 x 76	
03-0015	25 1/4 x 64		03-0147	28 7/8 x 64	02--10090--0010
03-0009	25 1/4 x 70		03-0164	28 7/8 x 70	02--10090--0011
03-0010	27 1/4 x 70		03-0165	28 7/8 x 72	02--10090--0012
03-0016	27 1/4 x 76		03-0018	28 7/8 x 72 1/4	



#364

Gasket Retainer

SKU	Dimensions (Inches)
96-0364	8' Stick

*For use with #365 Frame Mounted Dart Style

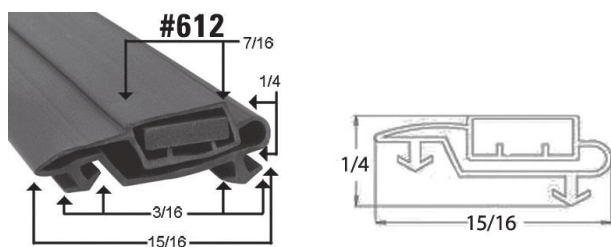

Model 1000 on Equipment Made Prior to November 1981

Most Popular Sizes

Frame Mounted Dart Style					
SKU	Dimensions (Inches)	OEM #	SKU	Dimensions (Inches)	OEM #
03-0121	21 3/4 x 50 3/4		03-0167	25 3/8 x 70	02--11393--0010
03-0122	21 3/4 x 64		03-0124	27 1/4 x 70	
03-0006	21 3/4 x 71		03-0125	28 3/4 x 64	
03-0120	21 5/8 x 33		03-0126	28 3/4 x 76	
03-0166	21 5/8 x 64	02--11393--0006	03-0127	28 3/4 x 70	
03-0123	25 1/4 x 70		03-0196	28 7/8 x 64	02--11393--0004



#611

Gasket Retainer

SKU	Dimensions (Inches)
96-0611	8' Stick

*For use with #612 Frame Mounted Dart Style

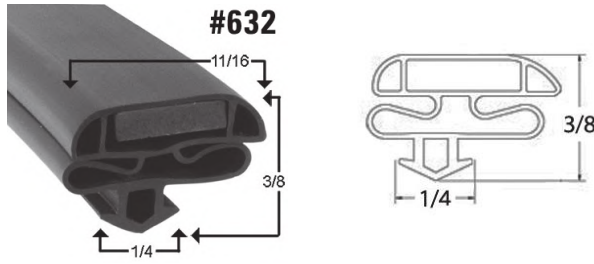

Low Profile Dart Style

*3 sides - Sizes may vary + or - 1/4" or more

SKU	Dim. (Inches)	Models	OEM Part#
03-0080	21 1/2 x 69 7/8		
03-0078	21 1/4 x 72 7/8		
03-0081	21 5/8 x 37 3/4		
03-0082	21 5/8 x 51 7/8	401 series	02-14799-0007
03-0083	21 5/8 x 64 7/8	401 series	02-14799-0003
03-0128	21 5/8 x 72 7/8	401 series	02-14799-0008
03-0168	21 3/4 x 65		02-60168-0001
03-0169	21 3/4 x 71	Display Rite	02-60168-0002
03-0084	22 7/8 x 73		
03-0085	23 1/4 x 57 1/8		
03-0170	23 3/16 x 65 1/16		02-14801-0010
03-0171	23 3/16 x 73 1/16		02-14801-0012
03-0086	23 5/8 x 59 1/4	44020	
03-0172	23 3/4 x 61 1/4		02-14800-0013
03-0087	24 x 27 1/2		
03-0088	24 x 58		
03-0089	24 3/8 x 59 3/4		
03-0134	25 1/8 x 63	6001	02-14800-0005
03-0092	25 3/4 x 59 3/4		
03-0090	25 3/8 x 64 7/8		02-14799-0009
03-0129	25 3/8 x 72 7/8	401 series	02-14799-0010
03-0091	25 3/8 x 73 1/4		
03-0172	25 1/2 x 65	Display Rite	02-60168-0003
03-0173	25 1/2 x 71	Display Rite	02-60168-0004
03-0174	25 3/8 x 30 7/8		02-15267-0002
03-0175	25 3/8 x 63 1/4		02-15267-0001
03-0176	25 13/16 x 48 9/16		02-14801-0011
03-0093	26 1/8 x 44 1/2	IS28AG, IS101AG	
03-0094	26 1/8 x 58 3/8		

SKU	Dim. (Inches)	Models	OEM Part#
03-0177	26 3/8 x 65 1/16		02-14801-0013
03-0178	26 3/8 x 71 1/16		02-14801-0014
03-0179	26 3/8 x 73 1/16		02-14801-0015
03-0180	27 1/16 x 61 1/8		02-14800-0015
03-0181	27 3/8 x 72 7/8		02-14799-0005
03-0182	27 3/8 x 76 7/8		02-14799-0011
03-0183	27 1/2 x 65		02-60168-0006
03-0184	27 1/2 x 77		02-60168-0007
03-0185	28 3/8 x 71 1/16		02-14801-0016
03-0186	28 3/8 x 73 1/16		02-14801-0017
03-0187	28 3/8 x 77 1/16		02-14801-0018
03-0095	28 1/2 x 76 3/4		
03-0098	28 7/8 x 58 3/8		
03-0096	28 7/8 x 64 7/8		02-14799-0002
03-0097	28 7/8 x 70 7/8		02-14799-0006
03-0133	28 7/8 x 72 7/8		02-14799-0001
03-0188	28 7/8 x 76 7/8		02-14799-0004
03-0189	29 x 65	Display Rite	02-60168-0008
03-0190	29 x 71	Display Rite	02-60168-0009
03-0191	29 x 77	Display Rite	02-60168-0010
03-0192	29 3/16 x 62 9/16		02-14801-0009
03-0099	29 3/4 x 62 5/8	R13DFRKT	
03-0100	29 7/8 x 58 3/8		
03-0193	29 7/8 x 58 1/12		02-14801-0022
03-0194	29 7/8 x 60 11/16		02-14801-0001
03-0195	29 7/8 x 62 13/16		02-14801-0002
03-0196	29 7/8 x 61 3/16		02-14801-0008
03-0197	29 7/8 x 65		02-14801-0005
03-0198	29 7/8 x 65 1/16		02-14801-0004
03-0199	29 7/8 x 71 1/16		02-14801-0007
03-0131	29 7/8 x 73 1/16	2001, 1201, 2103	02-14801-0003
03-0200	29 7/8 x 77 1/16		02-14801-0019
03-0101	30 x 77 1/4		
03-0102*	30 x 80 1/2		

 **Most Popular Sizes**

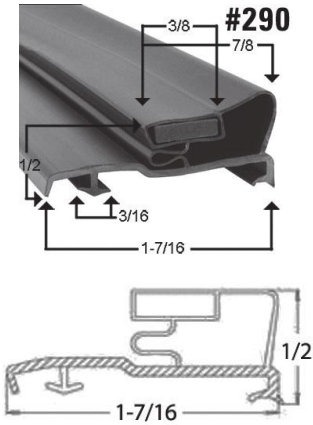

Dart Style Magnetic			
SKU	Door Dim (Inches)	Commonly Fits Models	OEM Part #
03-0146	23 1/4 x 63 1/16		02-81055-0002, 02-16050-0002, 13199-P002
03-0132	23 1/4 x 72	VR2372-2-N, VR23722N	02-81055-0097, 13199-P97
03-0144	29 15/16 x 66		02-81055-0005, 13199-P005
03-0145	29 15/16 x 72		02-81055-0007, 13199-P007
03-0040	29 5/16 x 63 1/16	Swingline, M-Line, VanGuard	02-81055-0011, 13199-P11
03-0077	29 5/16 x 67 1/16	WF-36761	02-81055-0264, 13199-P264

NOT SURE WHAT YOU NEED?

Work Order #



In order to match the correct gasket style and profile you will need to locate your **Work Order Number** on the data plate.

Call us and we tell you the exact gasket you need!

All Measurements are Outside Edge to Outside Edge Unless Otherwise Noted



Torque Master Reversible



SKU	Color	Part #
03-2001	Black	02-10568-0003*

SKU	Color	Part #
03-2002	Silver	02-10568-0001*

29" Torque Rod

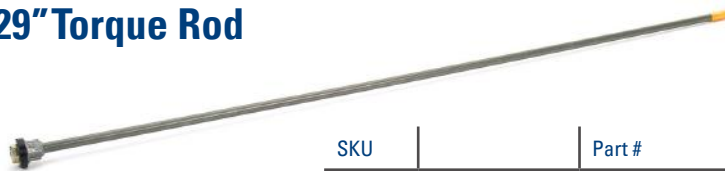

SKU	Part #
03-2003	89 to present 02-10568-0001*

Hinge Pin w/3 leads

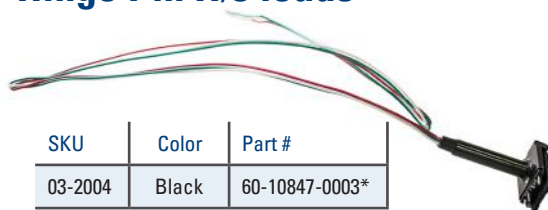

SKU	Color	Part #
03-2004	Black	60-10847-0003*

Hold Open



SKU	Color	Part #
03-2005	Black	15-14707-0001*

ANTHONY

Hold Open Assembly BLK New 95 to present



SKU	Color	Part #
03-2006	Black	02-14649-0001*

Hinge Pin w/ lead



SKU	Color	Part #
03-2007	Silver	60-10847-0004*

*Aftermarket

ARCTIC

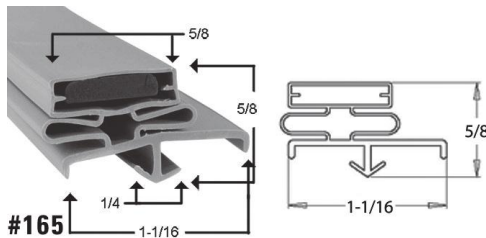

3-Sided Dart Style Magnetic

SKU	Dimensions (Inches)	OEM Part #	Notes
90-0001	36 x 77	59057	
90-0002	36 1/4 x 79	3036	Inverted

Making a Custom Gasket?



Ask About Our Sample Gasket Rings!

ARDCO

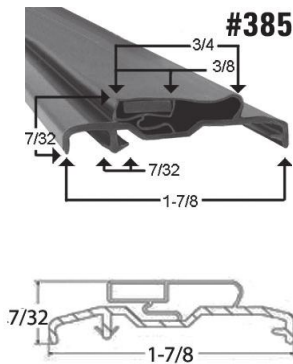

Most Popular Sizes

Dart Style Enertech Model Doors

SKU	Dimensions (Inches)	OEM Part#	SKU	Dimensions (Inches)	OEM Part#
04-0034	23 1/4 x 54 5/16	02--14579--0001	04-0131	29 5/16 x 60 3/8	02--14579--0015
04-0008	23 1/4 x 63 1/16	02--14579--0002	04-0126	29 15/16 x 58 1/16	02--14579--0012
04-0054	23 1/4 x 72	02--14579--0006	04-0133	29 15/16 x 63 1/16	02--14579--0004
04-0009	26 x 63 1/16	02--14579--0003	04-0134	29 15/16 x 65 3/16	02--14579--0017
04-0012	26 x 72	02--14579--0007	04-0010	30 x 63 1/16	
04-0013	26 x 80	02--14579--0010	04-0011	30 x 66	02--14579--0005
04-0130	29 1/4 x 55 11/16	02--14579--0014	04-0057	30 x 72	02--14579--0008
04-0132	29 1/4 x 63 1/16	02--14579--0013	04-0014	30 x 80	02--14579--0009
			04-0036	36 x 80	02145790011

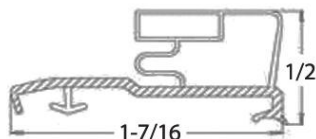

Most Popular Sizes

New Dart Style for Swingline II and III or Vanguard Doors

SKU	Dim. (Inches)	OEM Part #	SKU	Dim. (Inches)	SKU	Dim. (Inches)	
04-0080	15 1/4 x 44 1/16	02-81055-0146	04-0076	26 3/8 x 63 1/16	02-81055-0098	04-0028	29 7/8 x 51 1/4
04-0081	15 7/8 x 23 5/8		04-0025	26 1/2 x 63		04-0030	29 7/8 x 60 3/8
04-0100	21 7/8 x 31 1/2	02-81055-0271	04-0089	27 7/16 x 63	02-81055-0219	04-0029	29 7/8 x 61 1/8
04-0091	22 7/8 x 42 1/16	02-81055-0222	04-0083	27 5/8 x 63 5/16	02-81055-0160	04-0095	29 7/8 x 61 7/16
04-0024	23 x 72	02-81055-0097, 13199-P97	04-0017	27 3/4 x 60 1/4	02-81055-0021, 13199-P21	04-0032	29 7/8 x 72
04-0094	23 1/32 x 57 13/32	02-81055-0235	04-0018	28 x 57	02-81055-0041, 13199-P41	04-0065	29 15/16 x 31 3/8
04-0005	23 1/8 x 29 7/8		04-0021	28 x 63	02-81055-0040, 13199-P40	04-0074	29 15/16 x 51 5/16
04-0006	23 1/8 x 31 1/4		04-0079	28 1/16 x 67 5/16	02-81055-0135	04-0118	29 15/16 x 58 13/16
04-0068	23 1/4 x 29 13/16	02-81055-0044	04-0078	28 3/32 x 51 7/8	02-81055-0123	04-0088	29 15/16 x 61 1/16
04-0070	23 1/4 x 31 3/8	02-81055-0051	04-0097	28 3/16 x 60 5/16	02-81055-0249	04-0093	29 15/16 x 61 1/8
04-0007	23 1/4 x 54	02-81055-0001, 13199-P001	04-0103	28 3/16 x 74 5/16	02-81055-0299	04-0102	29 15/16 x 63 1/2
04-0046	23 1/4 x 63 1/16	02-81055-0002, 13199-P002	04-0022	28 3/4 x 63		04-0096	29 15/16 x 65 3/16
04-0085	23 1/4 x 71 3/16	02-81055-0168	04-0019	28 7/8 x 50 7/8		04-0071	29 29/32 x 30
04-0105	23 1/4 x 72	02-16050-0097	04-0020	29 3/16 x 55 9/16	02-81055-0057, 13199-P57	04-0051	30 x 63 1/16
04-0092	23 21/64 x 32 53/64	02-81055-0225	04-0027	29 1/4 x 47 1/2		04-0052	30 x 66
04-0082	23 5/8 x 31 1/4	02-81055-0153	04-0067	29 1/4 x 58 1/2	02-81055-0043	04-0053	30 x 72
04-0004	24 1/2 x 29 1/2	02-81055-0065, 13199-P65	04-0084	29 1/4 x 62 7/8	02-81055-0166	04-0050	30 x 80
04-0033	24 1/2 x 60 1/2		04-0016	29 1/4 x 63	02-81055-0011, 13199-P11	04-0072	31 x 41 15/16
04-0045	24 5/8 x 60 3/4	02-81055-0066, 13199-P66	04-0073	29 5/16 x 47 11/16	02-81055-0068	04-0044	32 x 70 1/4
04-0077	25 1/16 x 59 5/8	02-81055-0116	04-0075	29 5/16 x 58 13/16	02-81055-0093	04-0086	32 1/4 x 70 5/16
04-0098	25 3/8 x 66 13/16	02-81055-0250	04-0090	29 5/16 x 60 3/8	02-81055-0220	04-0026	32 1/4 x 77 1/4
04-0047	26 x 63 1/16	02-81055-0003, 13199-P003	04-0141	29 5/16 x 63 1/16	02-81055-0011	04-0087	32 9/16 x 63 1/16
04-0048	26 x 72	02-81055-0006, 13199-P006	04-0099	29 5/16 x 67 1/16	02-81055-0264	04-0069	33 3/4 x 66
04-0049	26 x 80	02-81055-0008, 13199-P008	04-0101	29 9/16 x 65 1/4	02-81055-0294	04-0015	35 3/4 x 80 1/4
04-0031	26 3/8 x 31 1/4	02-81055-0099, 13199-P99	04-0023	29 3/4 x 58 3/4	02-81055-0077, 13199-P77	04-0066	36 x 65

ARDCO

ARDCO

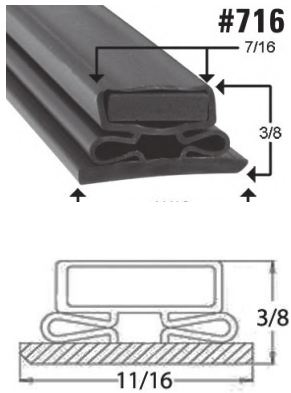

Gasket Style on Equipment Manufactured Between 1960 and 1970

Early Style Retainer Style for XL and Magni-Matic Doors

SKU	Dimensions (Inches)	SKU	Dimensions (Inches)	Commonly Fits Models
04-0037	22 1/4 x 53 3/8	04-0041	27 x 59 1/2	
04-0038	22 1/4 x 62 1/8	04-0042	28 1/4 x 59 3/4	
04-0035	23 1/4 x 72	04-0043	28 3/4 x 65	
04-0039	24 5/8 x 61 1/2	04-0002	30 x 60	
04-0001	26 x 63	04-0003	30 x 72	Enertech
04-0040	27 x 55			

BALLY

BALLY

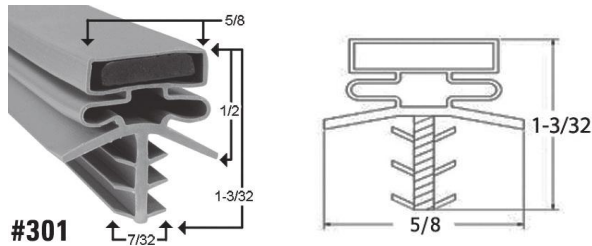

"New Style" Triple Dart Style

SKU	Dimensions (Inches)	Fits Models	OEM Part#	SKU	Dimensions (Inches)	Fits Models	OEM Part#
06-0005	6 3/4 x 9 5/8			06-0003	35 5/8 x 75 1/2		
06-0027	19 3/4 x 31 1/2			06-0002*	35 5/8 x 77 1/2		016546
06-0019*	21 3/8 x 31 3/8			06-0001	35 5/8 x 83 1/2		54117
06-0018*	22 3/4 x 62 3/4			06-0012*	35 5/8 x 66 1/4		
06-0016*	25 1/4 x 83 3/4	3666, 3676, 3677, 3678		06-0011*	36 x 78		
06-0017*	25 1/2 x 77 1/2		16543	06-0028*	37 1/2 x 77 5/8		
06-0015*	31 3/8 x 31 5/8			06-0010*	37 1/2 x 83 1/2	3484, 3482-3L-W	
06-0014*	31 5/8 x 77 1/2			06-0009*	43 1/2 x 83 3/4	3466, D, 3477, 3478	16547
06-0013*	31 5/8 x 83 1/2		17403	06-0008*	43 1/4 x 77 1/2	3476	
06-0029*	35 1/2 x 75 1/2		16545	06-0007*	49 5/8 x 77 1/2	3078-4-L, 017402	17402
06-0022	35 1/2 x 76			06-0006*	49 5/8 x 83 1/2		16548
06-0023*	35 1/2 x 78		35 1/2 x 78	06-0004*	61 5/8 x 83 1/2		

*3 sides

1255 Pacesetter Hinge



SKU	Description	Finish
75-0088	Textured Panel	Brushed Chrome
75-0089	Smooth Face	Polished Chrome

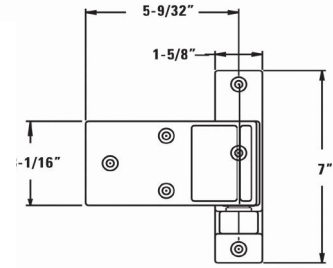

BEVERAGE AIR

Dart Style

SKU	Dim. (Inches)	Commonly Fits Models	OEM Part #
09-0088	14 5/8 x 19 3/4	UCR34	712-012D-13
09-0077	16 3/4 x 44 3/8	MM14GE, MM14	712-013C-06
09-0035	17 1/2 x 30 3/4	BB48GB, BB48GS	703-881C
09-0072	18 3/4 x 33		
09-0078	18 3/4 x 33 1/4	UR30, UR30GE	712-013C-07
09-0087	18 5/8 x 31 1/16	TDD501	712-032D-01
09-0041	19 x 30 1/4	BB72Y, BB72GB, BB72G	703-882C
09-0022	19 x 31 1/4	DD50	703-583C
09-0080	19 1/8 x 35 1/2	CT96	6160100140
09-0025	19 1/4 x 29 3/4	UR20, UR20GE	703-766C
09-0067	19 1/4 x 29 3/4	UR20GE, UR20,	703-766C
09-0096	19 7/8 x 25 1/4		
09-0052	21 x 29		703-195CAA
09-0011	21 1/4 x 29 1/2	BM23, 703-195CAA	703-195C
09-0084	21 1/4 x 30 7/8	DD781, BB78	
09-0104	21 1/4 x 31 1/2		703-587C
09-0021	21 1/2 x 31 1/2	DD78	703-372C
09-0082	21 3/4 x 41 1/2	MT10	712-013C-10
09-0076	21 3/4 x 49 1/2	RR12-1AS, MT12, KR12	712-005C
09-0075	21 5/8 x 49 1/2	KR12, CFG12, CFG121	712-013C-08
09-0053	22 1/4 x 31 1/2		703-375

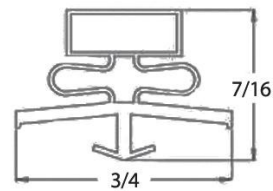
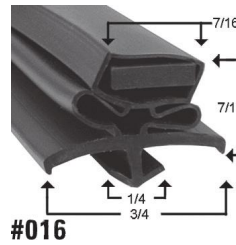

Dart Style

SKU	Dim. (Inches)	Commonly Fits Models	OEM Part #
09-0008	22 1/4 x 31 1/2	DD58, BB94, MS68	
09-0086	22 3/8 x 31 1/4	BB681, BB941B, BB68G	712-013C-12
09-0081	22 3/4 x 53 3/4	MT72W55, MT72B55	712-013C-05
09-0028	23 1/4 x 54 1/2		
09-0016	23 1/2 x 55	MT72	
09-0106	23 1/2 x 63 1/2		404-451C
09-0007	24 x 64	RF48	
09-0012	24 1/2 x 54 1/2	MT49/52	
09-0010	24 1/2 x 66 1/2	TSSU/TUC/TWT48/72	
09-0050	24 3/4 x 55	MT49/52	404-231C
09-0069	25 x 41 5/8		
09-0089	25 x 53 1/2	MT12, MT23, MT18	712-013C-02
09-0036	25 1/4 x 26	RI18HGS, RI18HGS	
09-0018	25 1/4 x 54	RI18	703-549C
09-0013	25 3/4 x 54 1/2	MT18/21	
09-0009	25 3/4 x 64	RF/RR24	
09-0020	27 7/8 x 54 1/4		
09-0051	28 1/8 x 54 5/16	QA-60-24MB-L	
09-0014	28 1/2 x 55		

BEVERAGE AIR

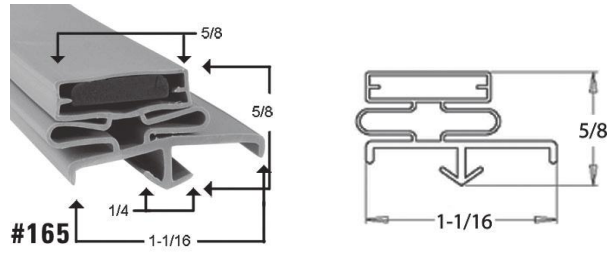

Dart Style

SKU	Dim. (Inches)	Commonly Fits	OEM Part#
09-0039	7 x 28 1/2	WTRCS52-1	712-012D-05
09-0038	9 x 28 5/8	WTRCS, 27-506	712-012D-04
09-0034	11 x 24	SPD27, WTRD27	703-963D-15
09-0070	11 1/8 x 21 1/8	SPED4812	703-963D-25
09-0019	11 7/8 x 23 1/8		703-963D-07
09-0100	12 1/4 x 23	DPD672, DP67	703-963D-28
09-0114	14 5/8 x 19 5/8		712-012D-13
09-0027	15 x 19 1/2	UCR34, ER341AS	703-963D-01
09-0026	15 1/4 x 22 1/2	DMC	703-963D-09
09-0047	15 3/16 x 19 9/16		703-410C
09-0017	17 x 19 9/16	UCR20, UCF20	703-963D-11
09-0030**	17 1/2 x 52 1/4	CRG36, CFG36	
09-0071	18 1/8 x 30 1/4		703-677C
09-0073	18 1/4 x 30 3/8	BB48B, BB48GS	
09-0074	19 5/8 x 30 3/8	BB72R, BB72	
09-0119	19 1/2 x 30 1/4	LV, BB72	703-678C
09-0037	19 7/8 x 25 1/4	LV, BB72	
09-0056	21 1/8 x 23		703-963D-03
09-0005	21 1/8 x 23 1/8	SP4812, SP48, SP72	
09-0046	22 3/4 x 23 5/8	D-26, URWT27	703-963D-26
09-0023	22 3/4 x 55 3/4	CF/CR, CF74-5W	
09-0042	22 3/4 x 62 5/8		
09-0083	22 5/8 x 50 3/8	LV12-1B, LV121B	712-031D-06
09-0045	22 7/8 x 30 3/4		
09-0121	22 7/8 x 62 3/4		712-012D-02

SKU	Dim. (Inches)	Commonly Fits Models	OEM Part #
09-0055	23 x 24		703-518C
09-0004	23 x 25 1/4	DP119, DP41, DP46	703-963D-05
09-0006	23 1/8 x 24	SP27, SP60, UC, UCF27, UCR-27	703-963D-02
09-0048	23 1/8 x 24 1/8	SUR27, SP60-16	703-963D-02
09-0015	23 1/8 x 31	HR1-1HS, HR2-1HS	712-012D-01
09-0003	23 1/8 x 62 3/4	GER241, EF241AS	712-012D-02
09-0061	23 1/8 x 63	HR1-1S, HR2-1S	712-012D-02
09-0058	23 1/4 x 25 3/16		703-589C
09-0064	23 1/4 x 54	HBR72-1, HBF72-1	703-963D-38
09-0127	23 1/4 x 56 1/4		703-963D-08
09-0057	23 3/8 x 63		703-538C
09-0002	24 x 52 1/2	KF48-1AS, KR745AS	703-988C-01
09-0029	24 1/8 x 54	LV49, LS49, RR49, RF49	703-963D-13
09-0129	25 1/4 x 53 7/8		703-876C
09-0054	25 1/4 x 54		703-513C
09-0059	25 3/8 x 54	R115	
09-0063	25 1/2 x 54	HBR23-1, HBF23-1	703-963D-40
09-0065	25 3/4 x 54 1/4	HBR23-1-G, HBF23-1-G	712-031D-01
09-0060	27 3/4 x 53 3/4	MT27B55	712-013C-03
09-0031	27 3/4 x 53 7/8	LV27-88/RR/RF27	703-963D-12
09-0001	28 1/8 x 53 3/4		703-875C
09-0032	30 x 66 3/8	PR121AS, SM58N	712-012D-03
09-0024*	30 x 66 3/4	PRI2, PRI1-1AS	703-665C
09-0132	31 1/8 x 62		712-012D-07
09-0062	32 1/8 x 63	HR1W-1S, HR1W-1G	
09-0040	32 1/4 x 63	E/P34	
09-0133	52		703-814B

*3 Sided

**Reverse Mounted

BEVERAGE AIR

BEVERAGE AIR

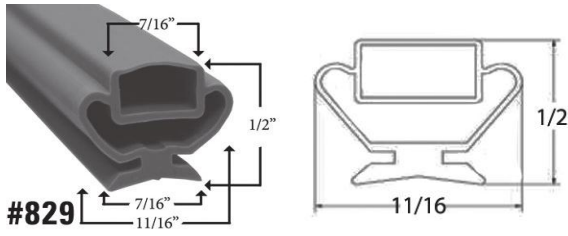

Retainer Style Santoprene			
SKU	Dim. (Inches)	Commonly Fits Models	OEM Part #
71-0006	20 3/4 x 57		783120
71-0002	21 5/8 x 28 5/8	CA43-CVMP6, TENDERTOUCHE CLASSIC	783180
71-0005	22 7/16 x 28 7/8		784712
71-0003	26 1/8 x 27 1/8		784719
71-0004	26 x 57 5/8	CA70-CVMP12	784024
71-0001	28 13/16 x 32 7/8	CS36-CH3, CS82-CH8	784820

BROWN

BROWN

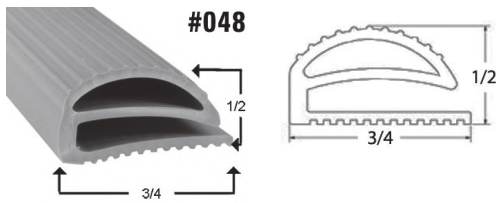

Compression Style	
SKU	Dimensions (Inches)
10-0003	35 1/2 x 79

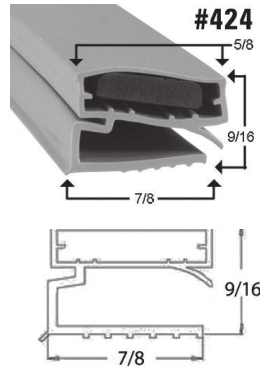

Screw In Style			
SKU	Dimensions (Inches)	Fits Models	OEM Part #
10-0020	25 3/4 x 65		
10-0021	35 1/2 x 77 3/4	UDS3, UDS4	
10-0022	35 1/4 x 73		
10-0035	35 1/4 x 77 3/8		138
10-0023*	49 3/4 x 84 1/2		
10-0024	50 1/2 x 78 1/2		137B
10-0025	55 3/8 x 78 3/8		

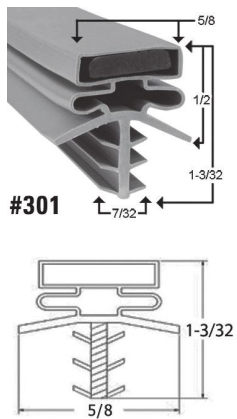

Triple Dart Style						
SKU	Dimensions (Inches)	Fits Models	OEM Part #	SKU	Dimensions (Inches)	OEM Part #
10-0017	23 3/16 x 32 1/4		138BJC	10-0009	35 1/2 x 77 3/4	
10-0018	23 3/16 x 34 7/8			10-0007	50 1/2 x 78 1/2	
10-0001*	24 1/2 x 82 5/8		136JC	10-0012*	36 x 82	
10-0026*	24 7/16 x 63 3/4		136CJC	10-0030*	36 3/8 x 82 15/16	138CJC
10-0019	25 1/16 x 64 3/8			10-0031*	42 1/2 x 80	138DJC
10-0002	25 3/4 x 65			10-0013*	43 1/8 x 80 5/16	
10-0027*	26 1/2 x 82 5/8		136JCS	10-0032*	48 9/16 x 80	137CJC
10-0010*	27 1/8 x 82 15/16			10-0006*	49 3/4 x 84 1/2	
10-0028*	28 3/16 x 34 1/4		136AJC	10-0014*	55 3/16 x 82 15/16	137BJC
10-0011*	30 7/8 x 82 15/16		138AJC	10-0008	55 3/8 x 78 3/8	
10-0029*	35 x 83		66313-1	10-0033*	58 3/4 x 80	1158JC
10-0005*	35 1/4 x 83 1/2	480E, UDF4, VDS4	138JC	10-0015*	59 x 80 5/16	
3 Sides				10-0034	60 9/16 x 84 3/8	138BJC
				10-0016*	61 3/16 x 84 11/16	

CONTINENTAL

CONTINENTAL

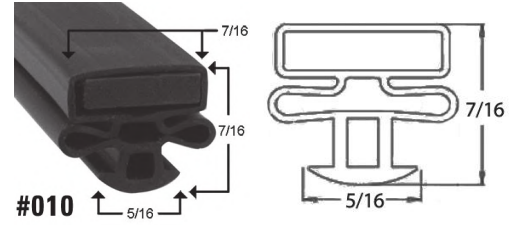
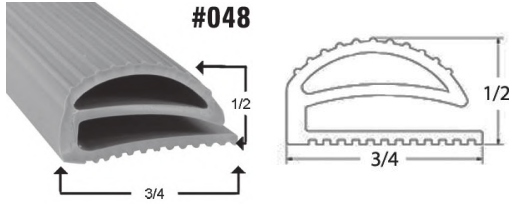

Compression Style					
SKU	Dimensions (Inches)	OEM Part #	SKU	Dimensions (Inches)	OEM Part #
12-0001	19 5/8 x 26 1/4	2--303	12-0029	24 1/4 x 61	
12-0002	19 5/8 x 55 1/8	2--305	12-0003	24 1/2 x 29 3/4	2--311
12-0028	22 3/4 x 55 1/8		12-0004	24 1/2 x 61	2--310

Dart Style	
SKU	Dimensions (Inches)
12-0045	12 1/4 x 31 3/8

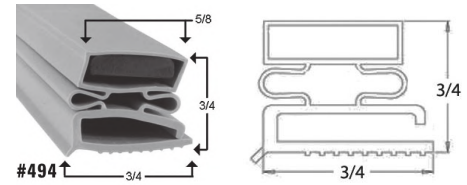
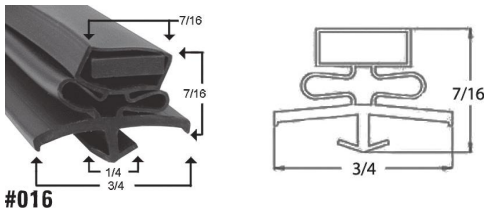

Dart Style		
SKU	Dimensions (Inches)	OEM Part #
12-0091	21 1/8 x 60 1/4	2--734

Screw In Style			
SKU	Dimensions (Inches)	Commonly Fits Models	OEM Part #
12-0006	23 1/4 x 26 3/4		
12-0110	23 3/8 x 26		2-244
12-0111	23 3/8 x 54 7/8		2-069
12-0112	23 5/8 x 29 1/4		2-312
12-0008	23 5/8 x 55 3/4		
12-0009	23 5/8 x 60 5/8	C2RDA2S, 2-307, A2RDA2S, 11RDS1S	2-307
12-0010	24 x 29 3/4		
12-0007	24 x 30	C1RFDA25, C1RFDA2A, C1RFDA2S	2-312
12-0018	25 3/4 x 27 1/4		
12-0013	25 5/8 x 55 3/4		
12-0024	29 1/2 x 66		
12-0019	31 1/4 x 61 7/8		
12-0023	31 x 60 3/4		

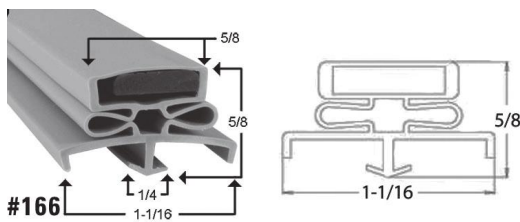

Centered Magnet Dart Style		
SKU	Dimensions (Inches)	Commonly Fits Models
12-0043	21 1/8 x 29 3/8	2RGDHD, 1RGDHD
12-0044	21 3/8 x 60 1/4	
12-0099	25 7/8 x 56 1/4	
12-0100	30 3/8 x 67 1/8	

CONTINENTAL

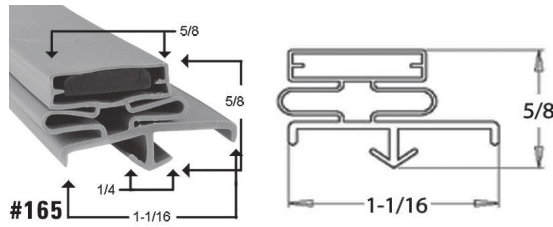

Santoprene Gasket

Dart Style

SKU	Dim. (Inches)	Commonly Fits Models	OEM Part#	SKU	Dim. (Inches)	Commonly Fits Models	OEM Part #
12-0036	7 1/4 x 24 1/2	DL1GSS, DL3GSS	2-743	12-0012	22 1/2 x 25 1/2	SW48, SW72-30M	2-705
12-0051	8 1/2 x 30 5/8	DL48G	2-815	12-0025	23 1/8 x 25 1/4	CPT117, CPT42, CPA93	2-711
12-0005	11 1/4 x 22 3/4	SWF48	2-717	12-0105	23 3/4 x 59 5/8		2-784
12-0026	11 5/8 x 15 1/8	CPA93, CPA68, CPA47	2-704	12-0041	23 7/8 x 29 9/16		
12-0033	12 1/4 x 23 3/8	SW72-30M, SW4812M	2-717	12-0103	23 7/8 x 60 1/2		2-728
12-0039	12 3/16 x 27	SW27, SW60	2-716	12-0030	24 x 60 3/4	GER241, EF241AS	
12-0017	12 1/2 x 24 1/4		2-712	12-0022	25 1/2 x 26 1/4	SW27BS, UCF27GD	2-706
12-0037	13 x 21 1/2			12-0047	25 1/2 x 30 3/4		
12-0046	14 3/8 x 60 1/2			12-0015	25 3/4 x 27 1/2		2-167
12-0050	15 1/4 x 30 3/4	BB48B, BB48GS, BB48R	2-610	12-0011	25 5/8 x 56 1/2		
12-0035	15 1/4 x 62 5/8		2-611	12-0014	25 7/8 x 56 1/4		2-166
12-0042	16 1/4 x 25 3/8		2-708	12-0038	29 3/4 x 31 3/4		
12-0027	18 x 30 1/4		2-714	12-0016	30 3/8 x 67 1/8		
12-0049	19 1/4 x 25 1/4	CPA60	2-725	12-0032	30 1/2 x 67 1/2		2-168
12-0034	20 5/8 x 30 1/4	KC79, KC59SS, KC69CT	2-713	12-0031	31 1/2 x 60 1/2	C30FA1S, DL1RXSS	2-722
12-0020	21 3/8 x 60 1/2	3RR, 2RFSA, DL1R	2-723	12-0040	32 1/4 x 60 7/8	PRI2, PRI1-1AS	
12-0021	21 1/2 x 29 3/4		2-726				

DELFIELD

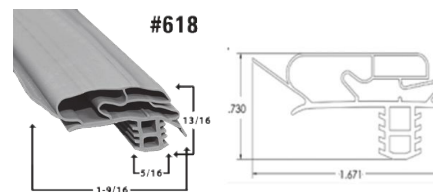
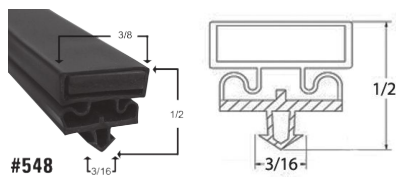

Glass Door Dart Style

SKU	Dimensions (Inches)	Fits Models	OEM Part #
13-0209	23 x 59 3/8	6025XLG, 6025XLGR, 6051XLGR	1701341
13-0234	24 3/4 x 28 7/8		
13-0210	24 3/4 x 51 1/4	VFR2G, VFR2RG, VFR3G, VFR3RG, VRR1G	1701285
13-0235	24 7/8 x 29		

Gasket

SKU	Notes
00-0618	Custom- Contact for Pricing

DELFIELD

DELFIELD

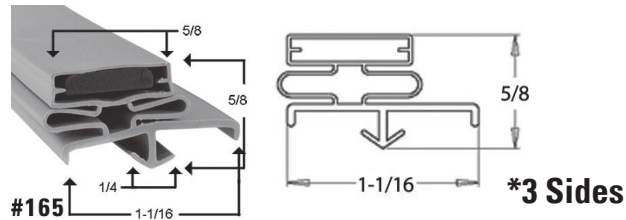

Dart Style

SKU	Dim. (Inches)	Fits Models	OEM Part #	SKU	Dim. (Inches)	Fits Models	OEM Part #
13-0007	9 x 24 1/2	C30FA1S, DL1RXSS	1702332	13-0182	23 x 27		
13-0010	11 x 28 3/4			13-0003	23 x 28 3/16		1702302
13-0008	12 x 29 3/4	D4032N, D4032R22	1701125	13-0004	23 x 59	6000 S/S, 170-2295	1702295
13-0011	13 1/4 x 20 1/2			13-0183	24 1/2 x 29	SLH29SH, SHPT1SH	1702210
13-0091	15 7/8 x 33 7/8			13-0006	24 1/2 x 29 1/4	Spec Line 1/2 SS Door	1702202
13-0054	16 x 48	NDF, NDFA12, NDF18	6700008	13-0147	24 1/2 x 60		1702209
13-0001	20 1/2 x 13 1/4	Spec Line Drawer	1702276	13-0267	24 1/2 x 60 1/2		1701294
13-0181	20 1/2 x 29	SLR25SH, 1702262	1702262	13-0067	24 3/4 x 60 3/4	Spec Line Snap in Full S/S Door	1702201
13-0087	20 1/2 x 60 7/8	SLF29S, SLR29S	1702261	13-0044	24 9/16 x 60 1/2	SLRPT29GG, SLF29S	
13-0031	20 7/8 x 21 7/8			13-0268	25 1/2 x 26 1/4		1701339
13-0262	21 3/16 x 23 11/16		1702750	13-0103	25 1/2 x 28 3/4		
13-0012	21 1/2 x 28 3/4			13-0101	26 1/4 x 29 3/4	4000N, ST4032N	1701120
13-0055	22 7/8 x 28 1/8	6025, 6025GHG	1702302	13-0122	26 1/8 x 29 7/16	4132F404A, 4046N24	1701120
13-0061	22 x 26	UC4048, UC4048N	1701127	13-0175*	29 1/2 x 72	SLRRI34S, SLFRI34G	1702203
13-0009	22 x 26 1/4	UC4048N	1701127	13-0271*	29 1/2 x 75		1702219
13-0005	23 13/16 x 45 1/2	ACR-26S	1701147	13-0272*	29 1/2 x 78		1702242
13-0069	23 3/4 x 45 1/2	ACR26S, 92985	92985	13-0233	29 3/4 x 72		

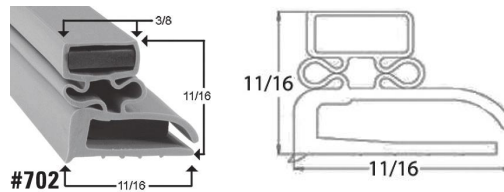

Old Style Screw In

SKU	Dim. (Inches)	OEM Part #	SKU	Dim. (Inches)	Fits Models	OEM Part #	SKU	Dim. (Inches)	Fits Models	OEM Part #
13-0141	7 5/8 x 24 1/2	1702011	13-0204	13 1/2 x 24 13/16	D400F12		13-0042	23 1/4 x 61 1/2		
13-0140	9 x 15	1702007	13-0206	15 1/4 x 20 5/8	V18354PT	1702001	13-0098	24 3/8 x 59 7/8		1702005
13-0118	9 1/4 x 15 1/4		13-0049	15 3/4 x 27 1/4			13-0035	24 9/16 x 25 7/16	V18672PTB	1702110
13-0205	9 1/2 x 21 1/4		13-0237	20 5/8 x 21 1/4			13-0036	24 3/4 x 27 1/4		1702004
13-0043	11 5/8 x 13 5/8		13-0100	21 3/4 x 27 1/4		1702090	13-0038	24 13/16 x 27 1/4	18699PT	1702004
			13-0099	23 1/8 x 28 1/2		1702056	13-0120	27 1/4 x 21 13/16	UC4048N	1702090

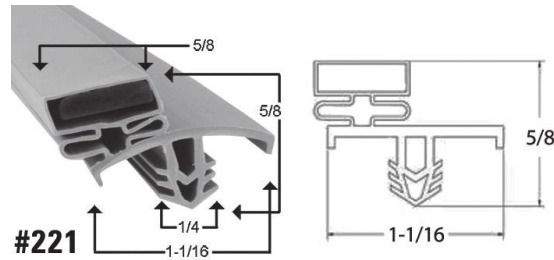

Push In Style

SKU	Dim. (Inches)	Commonly Fits Models	OEM Part #	SKU	Dim. (Inches)	Commonly Fits Models	OEM Part #
13-0138	9 5/16 x 24 7/8	SRR1GH		13-0075	24 x 25 3/16		
13-0273	9 5/16 x 25 1/6		1702693	13-0032	24 x 30	1 1/2 Door Vantage	1701289
13-0274	11 3/8 x 29 1/4		1702812	13-0080	24 x 51 1/2	Vantage Series	1701289
13-0275	21 1/16 x 29		1702747	13-0117	24 x 61	Full Door Vantage Series	1701288
13-0178	21 x 23 3/4			13-0081	24 1/8 x 51 1/2		1702640
13-0276	21 1/16 x 59 1/4		1702676	13-0083	24 1/4 x 29 3/4	VFR2SH, VRR1SH	1701319
13-0278	21 1/16 x 59 5/16		1702746	13-0085	24 1/4 x 60 7/8	VFR1S, VFR2RS, VFR2S	1701318
13-0277	21 1/8 x 59 1/4		1702638	13-0286	24 7/8 x 28 15/16		1702636
13-0095	21 1/8 x 29			13-0289	25 1/16 x 29		1702674
13-0096	21 1/8 x 59 1/2			13-0290	25 1/16 x 59 15/16		1702673
13-0179	22 3/4 x 28 3/8		1702797	13-0133	25 1/8 x 29 1/4	MRR1-SH, MFR1-SH	1702745
13-0149	22 3/4 x 28 1/2		1702797	13-0291	25 1/8 x 59 5/16		1702635
13-0097	22 3/4 x 58 5/8	6025XL-G, 6025XL-GH	1702796	13-0132	25 1/8 x 59 3/8	MRPT1GS, MRPT1S, MFR1S	1702744
13-0236	22 7/8 x 27 7/8			13-0105	25 1/2 x 30 1/4	4432N, 4432N-12M	1702475
13-0090	23 x 27 7/8	6125XL-SH-RB1	1702752	13-0115	28 3/8 x 61	Full Door Vantage Series	1701318
13-0280	23 x 28		1702752	13-0180*	28 1/2 x 73 1/4		
13-0092	23 x 59 1/8	6025XLS, 6025XLSR		13-0135*	29 3/4 x 72 1/4	SRRI2S	1702637
13-0282	23 1/4 x 28 1/4		1701280	13-0116	30 x 72 1/2	MFR1-S, MRR1-S, MRRI2-S	1702637
13-0033	23 3/8 x 30	1/2 Door Vantage Series	1701319	13-0139*	30 1/4 x 73	MRRI2S	1702748
13-0082	23 3/4 x 29 3/4			13-0292*	30 1/16 x 72 1/2		1702748
13-0084	23 3/4 x 61	VFR3RS, VRR1RS	1701288				
13-0283	23 7/8 x 25 1/16		1702641				
13-0146	24 x 25 1/8		1702641				

*3 sides

DELFIELD

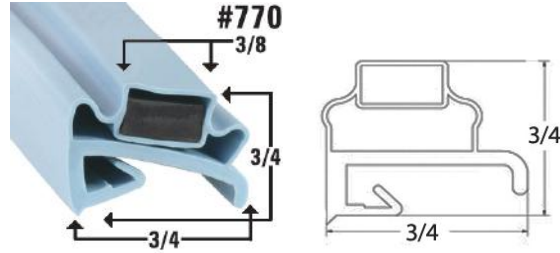

Retainer Mounted Gasket

SKU	Dim. (Inches)	Commonly Fits Models	OEM Part #	SKU	Dim. (Inches)	Commonly Fits Models	OEM Part #
13-0196	7 1/2 x 24 5/8		1702011	13-0199	14 7/8 x 18	Taco Bell Equipment	
13-0177	9 1/8 x 15 5/8	V1847232, 15048R12, 15048R22	1702007	13-0200	15 1/8 x 21 3/8		
13-0195	9 1/8 x 21 5/8	15048R12, 15048R22, 15072R12		13-0201	15 1/2 x 20 5/8	V18336, V18342, V1834232, V18354	
13-0198	9 1/4 x 24 1/4			13-0176	20 1/2 x 21 9/16	V1878432, V18324, V1832432, V18342	1702003
13-0197	13 x 29 1/2	D4032, 1701077, 170-1077	1701077	13-0202	24 5/8 x 25 5/8	V18666BST, V18666BUC, V18381	
13-0194	14 7/8 x 15	Taco Bell Equipment, TBP30004	TBP30004				

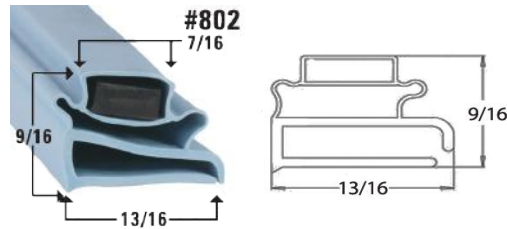

New Style Screw In

SKU	Dim. (Inches)	Commonly Fits Models	OEM Part #	SKU	Dim. (Inches)	Commonly Fits Models	OEM Part #
13-0121	7 3/4 x 24 3/4			13-0034	23 1/8 x 28 7/16	6000 122 door	1702056
13-0051	13 7/16 x 25			13-0041	23 1/8 x 59 5/16	170-2009, 6000 full door, 17-029	1702009
13-0014	13 1/2 x 29 1/2		1702275	13-0047	23 1/4 x 28 1/2	6000 122 door, 6025, 6025GHG	1702056
13-0320	13 1/2 x 24 13/16			13-0150	23 1/4 x 40 1/2		1702108
13-0052	13 1/2 x 29 7/8			13-0208	24 1/2 x 29	SRPT1GH, SLRPT56GHGH	1702168
13-0053	14 5/8 x 15 1/4			13-0015	24 1/2 x 60 1/2	Spec Line Full Glass Door	1702167
13-0037	15 1/4 x 20 5/8			13-0016	24 1/2 x 72		
13-0048	15 1/4 x 23			13-0046	24 9/16 x 27 1/4	406, 406CP	1702144
13-0143	15 5/8 x 27 1/4		1702146	13-0238	24 3/4 x 60 3/4		
13-0207	15 3/4 x 27 1/4		1702146	13-0148	24 5/8 x 27 1/4		1702144
13-0151	20 x 36 1/4		1702107	13-0106	26 13/16 x 29 1/2		1702274
13-0039	20 5/8 x 21 1/4			13-0123	27 x 29 3/4		
13-0050	21 3/4 x 27 1/4	4048, 4060, 4048-12, 406014	1702147	13-0107	29 1/2 x 72		
13-0040	21 13/16 x 27 1/4	4048, 4060, 17-027, 170-2147	1702147	13-0137*	29 3/4 x 72	Spec Line Snap in 3 Side S/S	1702170

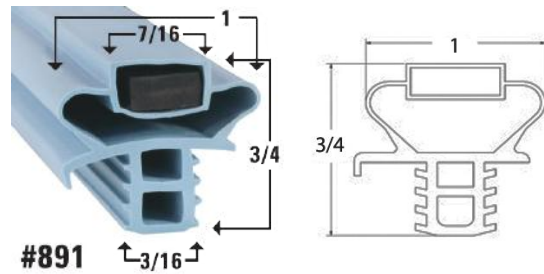

New Style Push In

SKU	Dim. (Inches)	Commonly Fits Models	OEM Part #	SKU	Dim. (Inches)	Commonly Fits Models	OEM Part #
13-0111	7 7/16 x 16 1/2	18RC83L, F2987C	1701194	13-0093	12 1/4 x 16 7/8		
13-0112	7 7/16 x 21 1/2	F2962CC, F2962C-C	1701195	13-0066	12 1/4 x 24 3/4		
13-0130	7 1/2 x 16 1/2	F17, F28, F29	1701194	13-0078	12 5/16 x 24 7/8	18699PTB	1702503
13-0108	7 1/2 x 21 1/3		1701195	13-0024	12 1/3 x 25	18000 Series	1702503
13-0129	7 1/2 x 24 1/4	F17, F28, F29, 17-325	1701196	13-0076	13 x 21 3/4	4448N12, D4448N	1702541
13-0128	7 1/2 x 29 1/4	F17, F26, F27, F28, F29	1701197	13-0029	13 x 24 7/8		
13-0113	8 x 16 15/16		1702508	13-0023	13 x 25	4427 Series, UCD4427N	1702524
13-0114	8 x 21 7/8		1702610	13-0079	13 x 27 3/4		1702542
13-0109	8 x 22	18000 Series	1702610	13-0239	13 x 27 7/8		
13-0110	8 x 25	18000 Series	1702510	13-0025	13 x 28	D4460N, D4460N-12	
13-0124	8 1/8 x 25 1/4	4427 Series, 4427N	1702476	13-0030	13 x 29		
13-0131	8 3/16 x 24 7/8			13-0074	13 x 30	4432 Series, 17-371	1702522
13-0136	8 1/4 x 30 5/16		1702478	13-0088	13 1/16 x 25	D4427N, D4427N6	1702524
13-0329	9 x 15		1702007-R	13-0337	13 1/16 x 29 7/8		1702522
13-0068	10 3/4 x 24 7/8	18RC60R	1701192	13-0142	13 1/8 x 22		1702541
13-0086	10 5/8 x 16 3/4			13-0062	15 3/8 x 16 3/8		1701187
13-0071	10 7/8 x 16 15/16		1701190	13-0063	15 3/8 x 21 1/4		1701188
13-0072	10 7/8 x 21 7/8	F18RC60, 18699PTB	1701191	13-0064	15 3/8 x 24 1/4		
13-0027	10 7/8 x 29 7/8		1701193	13-0240	15 3/8 x 24 3/8		1701189
13-0028	10 7/8 x 29 7/8			13-0341	15 7/8 x 23 7/8		
13-0057	11 x 30	18RC96R	1701193	13-0018	16 1/3 x 15 3/8		1701187
13-0334	11 7/8 x 18 13/16			13-0021	16 3/8 x 7 1/2		1701194
13-0094	12 x 18 3/4			13-0060	16 7/8 x 23 7/8	18RC60R, 18WC39R	1701183

DELFIELD

DELFIELD

(#891) New Style Push In (Continued)

SKU	Dim. (Inches)	Commonly Fits Models	OEM Part #	SKU	Dim. (Inches)	Commonly Fits Models	OEM Part #
13-0019	17 x 8	18000 series		13-0017	23 7/8 x 24 7/8	18648-BUC, 18648-PTB	1701185
13-0022	17 x 10 7/8		1701190	13-0193	23 7/8 x 24 7/8	18RC83L, 18RC83R, 17-268	
13-0020	17 x 12 1/3	18000 series	1702502	13-0070	23 7/8 x 29 7/8	18000 Series, CTB Series	1701186
13-0089	19 x 20	TBP60124		13-0056	24 x 24 7/8	18699PT, 18666PT, F18WC60	
13-0144	21 3/4 x 27 1/2		1702622	13-0026	24 1/4 x 15 1/2	Mark V	1701189
13-0059	21 7/8 x 24	F15, Serview, Mark 7, F18, F5	1701184	13-0065	24 3/4 x 27 1/2	406, 406CA-DHL, 406CADHL	1702623
13-0152	22 x 24			13-0126	25 3/8 x 25 1/2	4400 Series	1702475
13-0145	22 3/8 x 25 1/2		1702473	13-0125	25 1/2 x 25 1/2	4400 Series, 44276, UCD4427	1702474
13-0077	21 7/8 x 27 5/8	UC4048R, 42488, 4248P		13-0134	25 1/2 x 28 5/16	4460, 4460N, 4460N-12	1702562
13-0211	22 1/2 x 25 1/2	4448N-12, 4472N-12		13-0241	25 1/2 x 28 9/16		
13-0349	23 13/16 x 24 13/16		1701181	13-0127	25 1/2 x 30 3/8	44648, 4464N, 4464N12	1702475
				13-0242	25 1/2 x 30 1/2		

Dart Style

SKU	Dim. (Inches)	Fits Models	OEM Part #	SKU	Dim. (Inches)	Fits Models	OEM Part #
13-0153	5 5/16 x 29 3/16		1701062	13-0186	12 x 24 3/4		
13-0156	5 13/16 x 20 7/8		1701069	13-0187	12 1/4 x 24 3/4		
13-0170	7 3/8 x 24 1/4	V18660PTB	1701101	13-0165	15 1/4 x 21 3/8		1701154
13-0172	7 3/8 x 24 13/16		1701084	13-0188	15 5/16 x 15 3/4	TBP30042	
13-0169	7 3/8 x 24 3/16		1701065	13-0161	15 3/8 x 18 3/4	TBP30037	
13-0244	7 3/8 x 24 3/8		1701101	13-0189	15 3/8 x 27 1/2	4448N12, D4448N	
13-0154	7 3/8 x 29 3/8		1701102	13-0247	15 13/16 x 20 7/8		
13-0243	7 5/16 x 29 3/16			13-0160	15 13/16 x 23 3/8		1701098
13-0245	7 1/2 x 29 3/8			13-0190	16 x 23 1/2		
13-0155	9 3/8 x 24 3/4		1701111	13-0191	16 x 26 3/8		
13-0159	9 1/2 x 15 13/16	V17960114	1701057	13-0162	18 7/8 x 19 13/16	TBP60017	
13-0246	9 1/2 x 21 13/16			13-0164	19 13/16 x 20 7/8	TBP60009	
13-0166	9 1/2 x 21 7/8	V1857832	1701058	13-0192	20 3/4 x 24 3/4		
13-0184	9 1/2 x 24 7/8			13-0157	20 7/8 x 21 7/8		1701070
13-0174	9 1/2 x 29 13/16	4427 Series	1702012	13-0167	21 7/8 x 23 3/8	V186114PTB	1701099
13-0185	9 1/2 x 29 3/4			13-0168	22 x 26	UC4048, UC4048N	1701127
13-0158	11 13/16 x 18 7/8	TBP60016		13-0173	23 1/2 x 24 3/4	18670PTB, V18670PT	1701141
13-0163	11 13/16 x 20 7/8	TBP60010		13-0248	24 13/16 x 26 1/8		

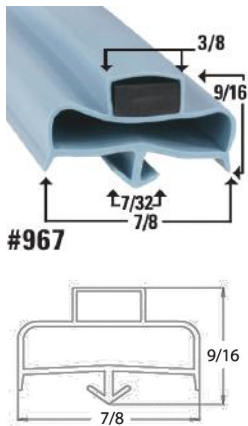

FLORIDA STAINLESS

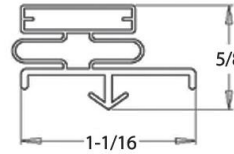
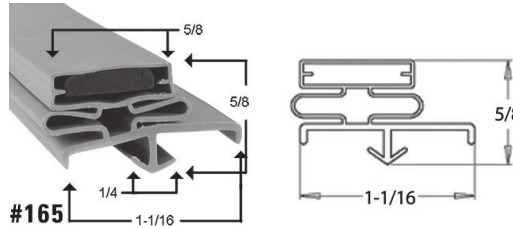
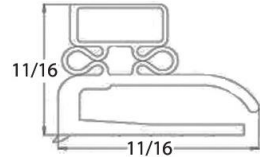
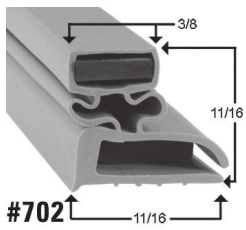

Screw In Style

SKU	Dimensions (Inches)	OEM Part #
19-0028	8 X 24 ⁵ / ₈	2672130
19-0029	8 X 24 ³ / ₈	2672002
19-0030	9 ¹ / ₈ X 20 ³ / ₈	2672139
19-0031	11 ⁷ / ₁₆ X 25 ³ / ₄	2672135

Dart Style

SKU	Dimensions (Inches)	OEM Part #	SKU	Dimensions (Inches)	OEM Part #
19-0005	7 9/16 x 24 1/4	2672142	19-0013	10 1/2 x 23 ⁵ / ₁₆	2672132
19-0006	8 x 16 3/8	2672158	19-0014	11 x 29 1/4	2710195
19-0003	8 x 24 3/8	2672140	19-0015	11 1/4 x 18 1/2	2672186
19-0004	8 x 28 7/8		19-0016	11 7/16 x 25 3/4	2672136
19-0007	8 x 28 15/16	2672156	19-0017	12 x 29 1/4	2678270
19-0008	9 x 29 1/4	2678230	19-0018	16 1/2 x 25	2672176
19-0009	9 1/8 x 20 3/8	2672133	19-0019	16 1/2 x 26 1/2	2672172
19-0010	9 3/8 x 25 1/8	2676220	19-0020	16 3/4 x 17 1/2	2675103
19-0011	9 3/8 x 30 1/8	2676240	19-0021	16 7/8 x 21 1/2	2672184
19-0012	10 1/2 x 23 3/8	2672134	19-0022	17 1/2 x 28 3/4	2675102

GLASTENDER

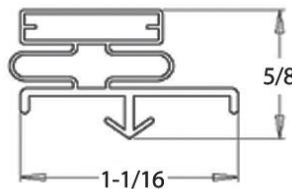
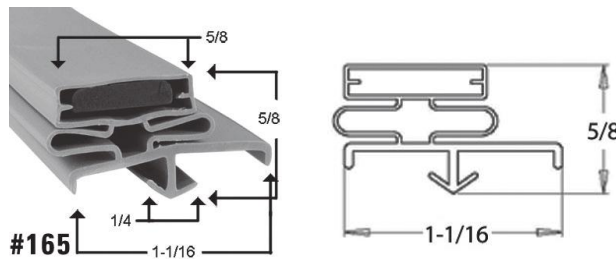

Dart Style Gasket

SKU	Dim. (Inches)	Commonly Fits Models	OEM Part #	SKU	Dim. (Inches)	Commonly Fits Models	OEM Part #
22-0018	18 1/2 x 32		6006178	22-0012	23 3/8 x 23 5/8		7000131
22-0006	19 1/4 x 32 1/2	ND72-L1-SS(RLR), 06001309	6001309	22-0010	23 3/8 x 25 3/8	LC, LETTUCECRISPER	11000068
22-0014	22 3/8 x 32	BB84L1BNH, BB84R1BNH	6004390	22-0011	23 1/2 x 24 7/8		
22-0020	22 1/2 x 23		6003713	22-0005	23 1/2 x 26 1/2	BB96, FV48, LP108, LP48, LP72	GT-031317
22-0002	23 1/4 x 23 3/4	MFV24-SSL		22-0003	23 1/2 x 32 1/2	BB96-L1-DNN, BB84, BB60	GT-031307
				22-0013	23 5/8 x 32 5/8		

HOBART

Screw In Style

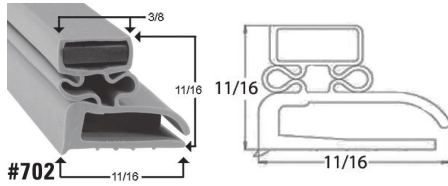

SKU	Dimensions (Inches)	OEM Part #	SKU	Dimensions (Inches)	OEM Part #
25-0015	25 1/4 x 57 3/4		25-0013	37 1/2 x 78 1/2	
25-0014	29 1/2 x 69	263233	25-0012	37 3/4 x 80	
25-0022	31 1/2 x 79		25-0082	37 5/8 x 79 1/2	206898

Glass Door Gasket

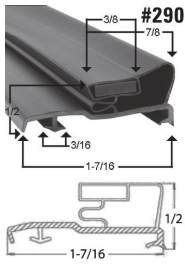

SKU	Dimensions (Inches)	Commonly Fits Models	OEM Part #
25-0027	26 1/4 x 31		268420-17
25-0025	26 1/4 x 62 3/4	Q2-5, D1, DA1, DA2, DA3, Q, Q2, Q3	268420-8
25-0028	32 x 70 1/4		

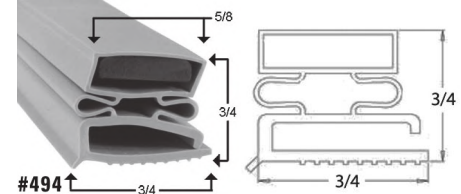

Screw In Style

SKU	Dimensions (Inches)	OEM Part #
25-0001	25 1/4 x 55 5/8	
25-0068	25 1/4 x 57 1/4	263231

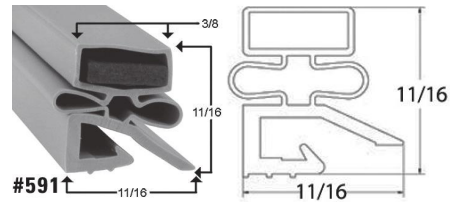
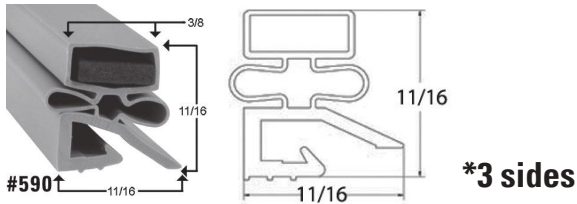

Retainer Mounted Gasket

SKU	Dim. (Inches)	Commonly Fits Models	OEM Part #
25-0019	7 1/2 x 24 1/4		280984-6
25-0069	7 7/8 x 24 1/2		280984-28
25-0039	8 x 24 3/4		
25-0020	9 1/8 x 24 1/4		
25-0029	10 1/4 x 24 1/2		
25-0051	12 3/8 x 24 3/4	DUP3	
25-0018	13 1/4 x 24 1/2		280984-7
25-0031	16 1/2 x 24 1/2		280984-29
25-0030	17 x 24 1/2		
25-0035	21 3/8 x 61 5/8		
25-0016	24 1/2 x 25 1/2	DU2, U2R, US3, USF2, USP3	280984-5
25-0010	24 1/2 x 29 5/8	H2, DA2, DAF1, 280984-2, HV1	280984-2
25-0038	21 1/2 x 30		280984-14
25-0056	24 1/8 x 29 5/8	QH1, QH2	265746-2
25-0073	24 1/4 x 29 1/2		268821-2
25-0075	24 1/4 x 60 5/8		265746-3
25-0076	24 1/4 x 61		268821-3

Retainer Mounted Gasket

SKU	Dim. (Inches)	Commonly Fits Models	OEM Part #
25-0023	24 1/2 x 61	HH1, QADH1, QH2, QSDH2, 283091-9	283091-9
25-0063	24 1/2 x 60 3/4		
25-0064	24 3/4 x 61 1/2		
25-0052	25 x 28 1/2		
25-0057*	25 1/2 x 24 1/4		
25-0011*	29 1/2 x 68 1/2	HEF1, HEF2, HE1, HE3, HE2	280984-10
25-0037	29 3/4 x 30 1/2	DA10BS, DA10, QLF1, DAW1, QSAW1	280834-9
25-0017	29 3/4 x 34 1/2		
25-0079	29 3/4 x 30 3/4		280984-31
25-0053	30 1/2 x 33 1/2	DE1, DE2, DEF2, QE, QE1, QE2	
25-0036	30 1/2 x 61		
25-0055*	30 1/2 x 69 1/4	DE1, DE2, DEF2, QE, QE1, QE2	283091-1
25-0032*	30 1/2 x 69 5/8	QE2R	280984-17
25-0081*	30 1/2 x 76		280984-18
25-0054*	30 1/2 x 76 1/2	EQE2	

HOSHIZAKI

HOSHIZAKI

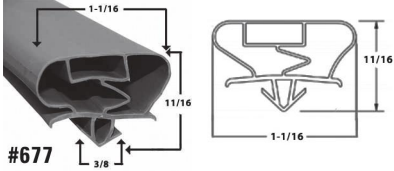

Dart Style	
SKU	Dimensions (Inches)
00-0677	Custom- Call for Pricing

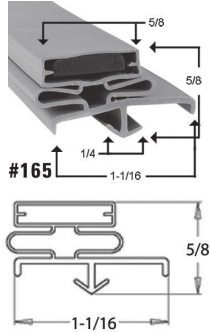

Dart Style			
SKU	Dimensions (Inches)	OEM Part #	Fits Model
76-0002	23 3/4 x 28 3/4	3A0273--02	
76-0003	26 X 30 1/2	2A519202	
76-0004	23 1/2 X 20 1/2	2A519222	CF1S-HSL

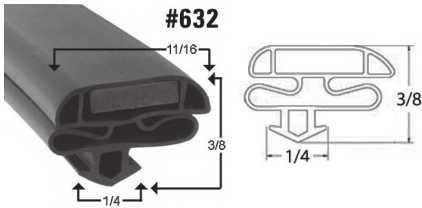

Dart Style		
SKU	Dimensions (Inches)	OEM Part #
76-0001	25 5/16 x 63 3/8	3A684301

KAIRAK

KAIRAK

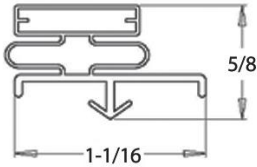
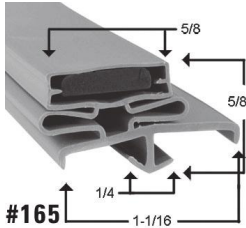

Most Popular Sizes

Dart Style

SKU	Dimensions (Inches)	OEM Part #	SKU	Dimensions (Inches)	OEM Part #	SKU	Dimensions (Inches)	OEM Part #
30-0015	6 7/8 x 29 1/8		30-0001	15 3/8 x 21 5/8	3500825	30-0049	21 x 29	3501000
30-0007	7 1/8 x 28	3500600	30-0022	16 7/8 x 20 1/4		30-0039	21 1/8 X 25 1/2	
30-0012	7 7/8 x 41 7/8		30-0002	17 3/16 x 24 13/16	3500707	30-0016	21 1/8 x 29 1/8	
30-0008	8 1/16 x 24 1/4	3500700	30-0004	18 x 21 5/8	3500850	30-0005	21 5/8 x 24 3/8	3501001
30-0009	8 1/8 x 20 1/8	3501103	30-0044	18 x 22 7/8	3500520	30-0026	22 x 22	
30-0042	8 1/2 x 16 3/8	3500800	30-0003	18 1/8 x 20 1/2	3500706	30-0006	22 7/8 x 24 1/8	3500500
30-0020	11 3/8 x 24 1/2	3500416	30-0038	18 3/4 x 19 1/8		30-0040	23 x 24 7/8	
30-0021	12 1/8 x 16 7/8		30-0025	19 1/8 x 20 5/8		30-0041	23 x 25 1/8	
30-0027	12 7/8 x 20 3/4		30-0024	19 1/8 x 24 1/2		30-0017	23 3/4 x 29 7/8	
30-0037	15 1/8 x 24 1/8		30-0046	20 1/8 x 20 1/4	3501101	30-0018	24 3/4 x 25 3/4	
			30-0047	20 1/8 x 25 3/8	3501100	30-0019	25 3/4 x 29 3/8	
			30-0048	20 1/2 x 22 7/8	3500510			
			30-0023	20 3/4 x 27 1/8				

KELVINATOR

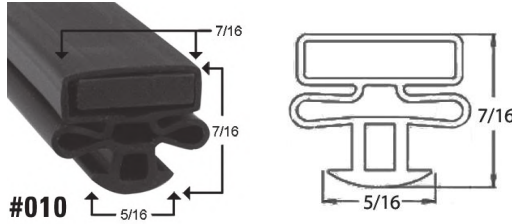

#010

Dart Style Gasket

SKU	Dimensions (Inches)	SKU	Dimensions (Inches)
31-0016	24 x 62	31-0001	29 1/8 x 63 1/4
31-0002	24 1/4 x 59 3/4	31-0008	29 3/4 x 62
31-0007	27 1/8 x 62	31-0003	31 3/4 x 59 1/2
31-0004	28 x 61 5/8	31-0006	31 3/4 x 62 1/2
31-0005	28 1/4 x 62 1/2		

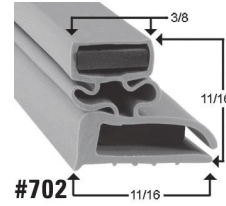

#702

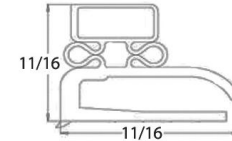

Reach In Door

SKU	Dimensions (Inches)
31-0015	26 3/4 x 55 1/2

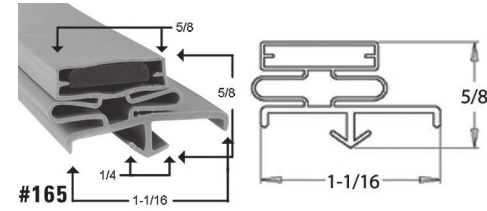

#165

Dart Style

SKU	Dimensions (Inches)	OEM Part #
31-0021	11 1/4 x 21 1/4	
31-0009	20 1/2 x 26 1/2	
31-0013	20 7/8 x 26 3/8	440936
31-0017	23 x 62 7/8	
31-0018	23 x 63	
31-0028	23 1/8 x 61 1/2	441083
31-0010	23 1/4 x 61 3/4	
31-0025	23 7/16 x 30 1/4	
31-0027	27 x 61 1/2	441081
31-0011	27 1/4 x 61 5/8	
31-0024	28 x 62 5/8	
31-0012	29 1/2 x 61 1/2	
31-0026	29 7/16 x 61 1/2	441080
31-0014	30 x 62	440901

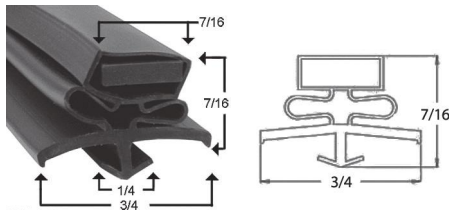

#016

Most Popular Sizes

Dart Style

SKU	Dim. (Inches)	Fits	SKU	Dim. (Inches)	Fits
31-0023	24 x 61 3/4		31-0029	29 1/2 x 64 1/2	T60LGP
31-0019	24 1/4 x 63 1/4	T50LGP	31-0022	30 1/4 x 62 3/4	
31-0020	29 1/2 x 64				

KOLPAK

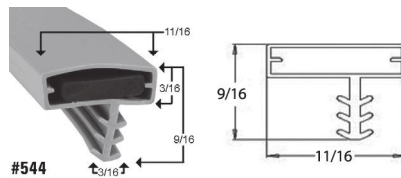

#544

3 Sided Jamb Mount Dart Style

SKU	Dimensions (Inches)	SKU	Dimensions (Inches)	OEM Part #
32-0034*	28 1/2 x 79	32-0030*	36 1/4 x 78	25567--1075
32-0033*	32 1/4 x 78 3/4	32-0022*	38 1/4 x 78 1/4	
32-0029*	34 1/4 x 78 5/8	32-0032*	44 1/8 x 79	

*3 sides

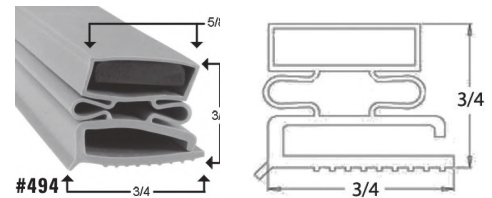

#494

Screw In Style

SKU	Dimensions (Inches)
32-0031*	32 1/2 x 77
32-0035*	38 x 79

*3 sides

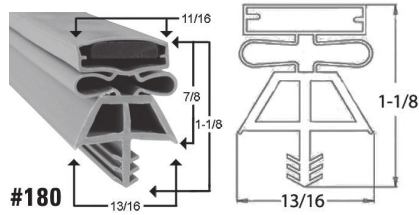

Most Popular Sizes

***3 Sides**
****3 Sides, 4 Corners**

Triple Dart Style Gasket

SKU	Dimensions (Inches)	Hinge	SKU	Dimensions (Inches)	Fits Models	Hinge
32-0011	22 1/4 x 38 1/4		32-0003	36 x 78		
32-0040	26 1/4 x 32 1/4		32-0082*	36 1/4 x 76 1/2		LH
32-0026*	26 1/4 x 77 1/2		32-0083*	36 1/4 x 76 1/2		RH
32-0019	28 1/2 x 66		32-0037	36 1/4 x 77		
32-0042*	28 1/2 x 77 1/2	LH	32-0021	36 1/4 x 78 1/4		
32-0074*	28 1/2 x 77 1/2	RH	32-0047*	36 1/4 x 78 1/4	18713S	LH
32-0051**	28 5/8 x 78 1/4		32-0048*	36 1/4 x 78 1/4	569n	RH
32-0020	32 x 78		32-0043*	36 3/8 x 77		
32-0036*	32 1/4 x 77	LH	32-0079*	36 1/2 x 66		LH
32-0050*	32 1/4 x 77	RH	32-0084*	36 1/2 x 66 1/2		
32-0028*	32 1/2 x 75	LH	32-0085*	36 1/2 x 77 1/2		
32-0076*	32 1/2 x 75	RH	32-0038*	36 1/2 x 77 1/2		
32-0007*	32 1/2 x 77	LH	32-0080*	36 1/2 x 84 1/2		LH
32-0027	32 1/2 x 78		32-0081*	36 1/2 x 84 1/2		RH
32-0077*	32 1/2 x 78	RH	32-0089	38 1/4 x 78 1/4		
32-0078*	32 1/2 x 78	LH	32-0023*	38 1/2 x 77 1/2		RH
32-0018	32 1/2 x 78 1/2		32-0049*	38 1/2 x 77 1/2	18709S	LH
32-0039	32 5/8 x 32 5/8		32-0086**	38 1/2 x 78		RH
32-0024*	35 1/4 x 79 1/4		32-0087**	38 1/2 x 78		LH
			32-0088*	44 1/4 x 77 1/4		
			32-0041	44 3/8 x 76 1/4		
			32-0025	50 3/8 x 78 1/2		

Door Sweep

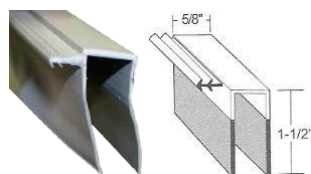

SKU	Dimensions (Inches)
32--0082	28"
32--0053	32"
32--0083	34"
32--0084	36"

KOLPAK

KOLPAK

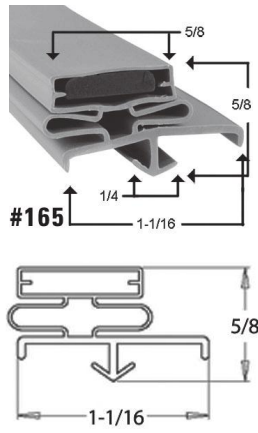

#165

*3 Sides
**3 Sides, 4 Corners

Dart Style

SKU	Dim. (Inches)	Hinge	SKU	Dim. (Inches)	Fits Models	Hinge
32-0070	19 3/4 x 55 3/4		32-0015	36 x 79 1/2		
32-0071	22 1/4 x 38 1/4		32-0004	36 x 79 3/4	K-0988-3	
32-0012	26 x 73 3/4		32-0065**	36 x 80 1/4		
32-0001	32 x 78 1/2		32-0010*	36 1/4 x 79		RH
32-0013	32 1/4 x 32 5/8		32-0046*	36 1/4 x 79	53311	LH
32-0014	32 1/4 x 38 1/4		32-0066*	38 x 77 3/4		LH
32-0008*	32 1/4 x 77 3/4	LH	32-0005	38 x 78 5/8		
32-0064*	32 1/4 x 77 3/4	RH	32-0072	38 x 79		
32-0009*	32 1/4 x 79	RH	32-0052*	38 x 78 1/2	DR3678, 63-076	RH
32-0045*	32 1/4 x 79	LH	32-0006	38 1/4 x 77		
32-0002	35 7/8 x 78 3/16		32-0067*	38 1/2 x 79		LH
32-0016	36 x 78		32-0068*	38 1/2 x 79		RH
32-0017**	36 x 78 1/4		32-0073	44 x 79		
			32-0069*	50 1/4 x 78 1/2		LH

LA ROSA

LA ROSA

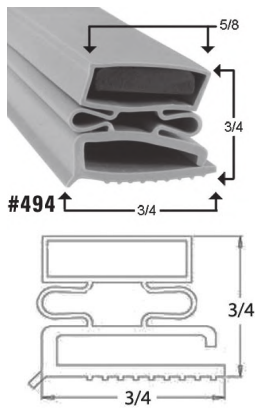

#494

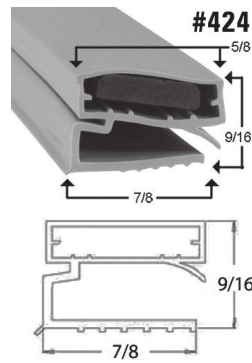

#424

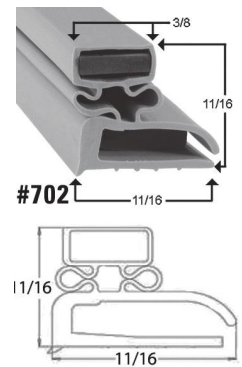

#702

Screw In Style

SKU	Dimensions (Inches)	OEM Part #
34-0004	7 3/8 x 22 7/8	
34-0006	15 1/8 x 21 1/8	12
34-0002	21 1/8 x 21 1/8	13
34-0005	23 1/2 x 24 1/2	

Screw In

SKU	Dimensions (Inches)	OEM Part #
34-0008	14 7/8 x 16	15
34-0003	23 9/16 x 24 1/2	14

Screw In

SKU	Dimensions (Inches)
34-0001	10 x 21 1/8
34-0007	21 1/8 x 21 1/8

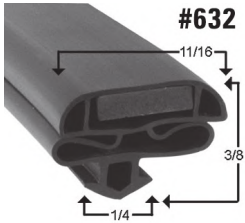

Low Profile Dart Style		
SKU	Dim. (Inches)	Fits Models
35-0023	21 3/4 x 37 3/4	M240GV
35-0024	26 1/8 x 44 1/2	M240GV, IS101AG, IS 28AG, IS41AG, IS6767, M1000AS, M240GV, M450AG, M650AG, M700AG

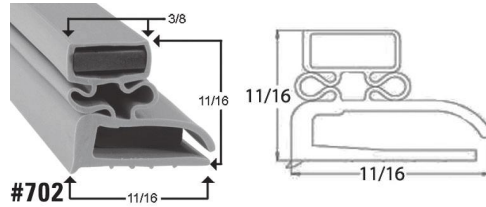
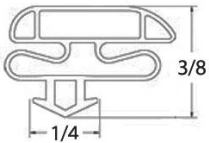

Screw In Style		
SKU	Dimensions (Inches)	OEM Part #
35-0003	26 1/2 x 26 1/2	
35-0004	26 1/2 x 46	
35-0033	26 3/4 x 46 1/8	103--0010
35-0034	36 x 80 3/8	103--0041

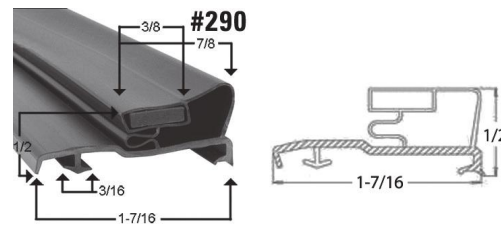
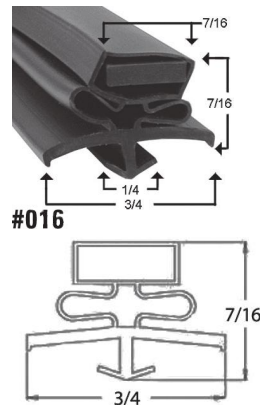
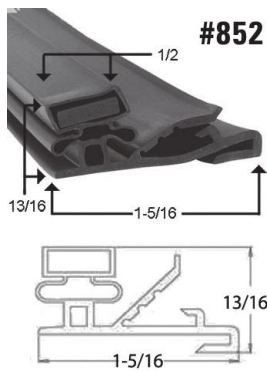

Glass Door	
SKU	Dimensions (Inches)
35-0010	21 3/4 x 37 3/4

Dart Style	
SKU	Dimensions (Inches)
35-0006	25 1/4 x 57 1/4

Dart Style		
SKU	Dim. (Inches)	Fits Models
35-0022	27 3/4 x 46 3/4	1002UA50MG

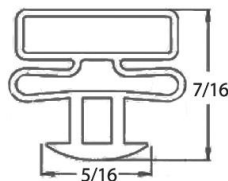
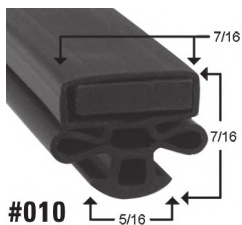
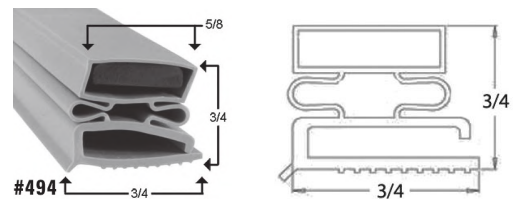

Dart Style			
SKU	Dim. (Inches)	Fits Models	OEM Part #
35-0005	27 x 46 1/4	401UC33MGF	1490007
35-0028	27 x 47		149--0007
35-0029	28 x 47		249--0007

Screw In Style		
SKU	Dimensions (Inches)	OEM Part #
35-0025	24 3/8 x 76 3/4 – LH	
35-0026	24 3/8 x 76 3/4 – RH	
35-0027	27 1/8 x 59	
35-0007	32 x 78	
35-0008	32 5/8 x 76 1/2	
35-0032	38 5/8 x 78 1/8	103--0082

LEER

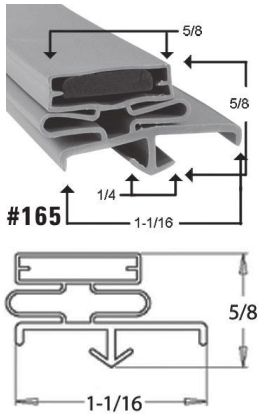

Dart Style

SKU	Dim. (Inches)	Fits Models	OEM Part #	SKU	Dim. (Inches)	Fits Models	OEM Part #
35-0011	22 1/4 x 28 3/8	M600		35-0015*	32 1/8 x 65 7/8		
35-0012	22 1/2 x 38 1/4			35-0016*	35 1/2 x 74 1/4		
35-0013	26 3/8 x 44 1/2	M1000AS		35-0002	36 x 78		
35-0014	26 1/2 x 26 1/2	LP610AS		35-0017*	36 x 78		
35-0020	27 x 27	602SC33MS		35-0031	37 7/8 x 64 3/4		103-0136
35-0021	27 x 45 3/4	1002UA50MS		35-0018*	38 x 66 1/2		
35-0030*	31 7/8 x 65 3/4		103-0133	35-0009*	38 x 78 3/4	DS3678FSF	1030136
35-0001	31 7/8 x 65 3/4			35-0019*	38 3/8 x 72 1/8		

*3 sides

MASTERBILT

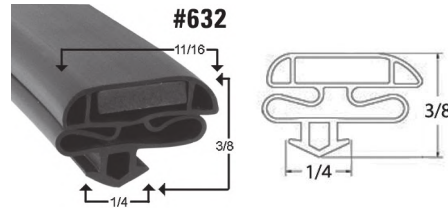
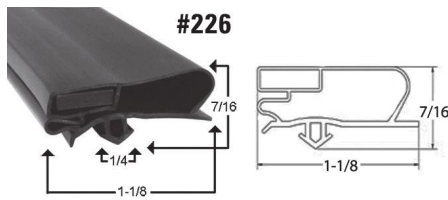

Glass Door

SKU	Dim. (Inches)	OEM Part #
37-0074	23 1/8 x 63	37-01280
37-0075	26 3/16 x 71	37-01299
37-0076	29 7/8 x 62 13/16	37-01273

Dart Style

SKU	Dimensions (Inches)	Commonly Fits Models	OEM Part #
37-0035	23 1/4 x 60 3/4	BMG-74, BLG48HD, BMG48, BLG74HD	37-01351
37-0070	23 7/8 x 52 3/8		37-01343
37-0039	28 1/4 x 60 3/4	BLG27HD	37-01350

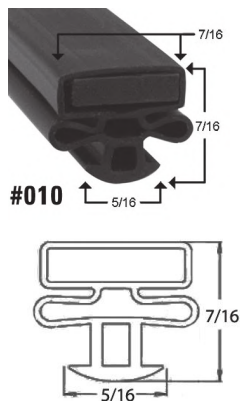

Glass Door

SKU	Dim. (Inches)	Commonly Fits Models	OEM Part #
37-0015	24 5/8 x 63	BMG74, BLG48HD, BLG48HDA, BLG48R	37-01189
37-0071	25 3/4 x 61 1/4		37-01352
37-0001	26 3/4 x 63	BLG52, BLG52HD, BLG52R, BLG80, BLG80HD	37-01181
37-0072	29 x 62 1/4		37-01182
37-0003	30 x 63		37-01182

MASTERBILT

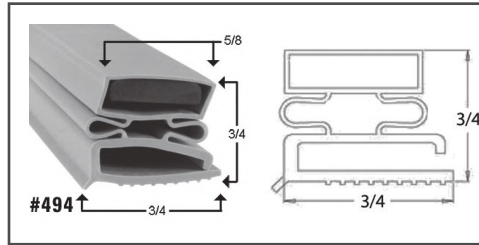
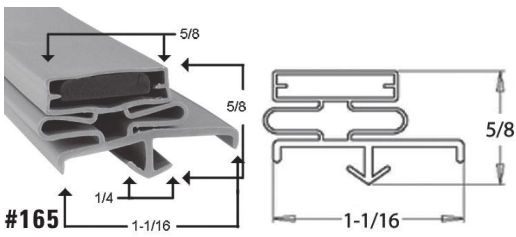

Screw-In Style

SKU	Dimensions (Inches)
37-0009	33 1/2 x 70 3/4
37-0010*	36 1/2 x 80

*3 Sides

Dart Style

SKU	Dimensions (Inches)	Fits Model	OEM Part #	SKU	Dimensions (Inches)	Fits Models	OEM Part #
37-0020	14 1/8 x 20 1/4			37-0024	27 1/2 x 60 3/8		37--01207
37-0017	16 x 26			37-0021	28 3/4 x 63 1/4		
37-0070	16 1/8 x 18 5/8		37--01188	37-0013	28 5/8 x 54		37--01220
37-0071	17 x 26 1/8		37--01187	37-0072	28 5/8 x 61		37--01164
37-0023	17 1/8 x 26 1/4			37-0037	29 1/4 x 34 3/8		
37-0002	17 1/4 x 19 1/2			37-0006	29 1/4 x 62 1/2		
37-0022	17 7/8 x 25 7/8			37-0030	29 1/2 x 61 3/4		
37-0018	18 x 19 5/8			37-0073	31 1/2 x 76		37-01025
37-0014	18 x 32			37-0031	31 5/8 x 77 1/2		
37-0025	20 1/8 x 27			37-0019	32 1/4 x 32 1/4		
37-0028	20 3/8 x 34 3/8			37-0007	35 3/4 x 75	D34RC08644	37-00502
37-0069	22 7/8 x 60 1/2			37-0027	36 x 78 1/8		
37-0008	23 x 60	IHC-48, TAC74HDSA	37-01211	37-0026	37 1/2 x 77 1/4	V39RC086XX	37-01254
37-0032	23 1/8 x 28 7/8			37-0038	37 1/2 x 78		
37-0011	23 5/8 x 62 1/4			37-0074*	37 3/4 x 75 1/4		37-00511
37-0004	23 3/4 x 62 1/2			37-0075	37 3/4 x 75 1/4		37-01255
37-0036	24 3/4 x 51 3/4			37-0012	37 3/4 x 75 3/4		
37-0005	26 1/2 x 62			37-0016	43 5/8 x 74 3/4		
37-0029	27 1/2 x 29						

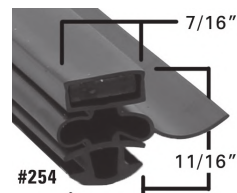
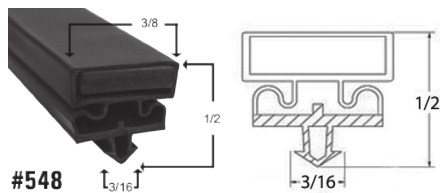

Dart Style

SKU	Dimensions (Inches)	OEM Part #
73-0075	24 1/4 x 61	37-01374

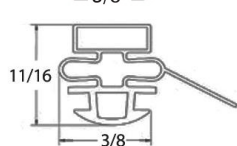

Dart Style

SKU	Dimensions (Inches)	Commonly Fits Models	OEM Part #
37-0033	22 1/8 x 26 1/4	SPT-48, UC-48DR, UC48DR	02-71056
37-0073	24 1/4 x 26 3/4		02-71337
37-0034	25 1/2 x 26 1/2	UC28SF, UC28SR	02-70993
37-0031	25 5/8 x 53 1/4	CCR-49DR, CCR49DR, WCR23SF	02-70984
37-0074	26 1/2 x 53		02-71337

MCCALL

MCCALL

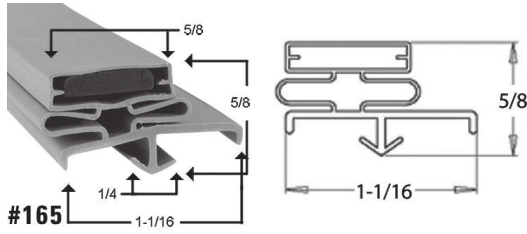

- Santoprene Gasket
- Most Popular Sizes

Dart Style							
SKU	Dim. (Inches)	Fits Models	OEM Part #	SKU	Dim. (Inches)	Fits Models	OEM Part #
38-0013	19 1/2 x 27		MCC13276	38-0046	24 1/2 x 26 1/2		MCC1449
38-0030	19 1/2 x 29 1/4		MCC13799	38-0033	25 1/4 x 25 1/2	R15E, RS15E	MCC14497
38-0027	19 1/2 x 29 1/2			38-0047*	28 3/8 x 73		170-2848
38-0006	19 1/2 x 46			38-0029	28 1/2 x 60 1/4		
38-0001	19 5/8 x 22 1/8			38-0048*	28 5/8 x 67 7/8		MCC203
38-0032	20 1/2 x 25 1/2		MCC14498	38-0025	28 3/4 x 29 1/2		
38-0015	21 x 30 1/2		MCC15247	38-0049*	28 3/4 x 66 1/8		MCC14064
38-0009	22 5/16 x 23 1/8	22018, 22018F	MCC1701	38-0002	28 3/4 x 68 1/4		
38-0024	22 7/8 x 27	BDT1102001CE		38-0016*	28 3/4 x 67 1/2	L1-1001F, L11001	MCC203
38-0010	22 7/8 x 29 3/4	DT1102001CE	MCC605	38-0023*	28 7/8 x 66 1/2		1702850
38-0028	22 7/8 x 29 5/8	1020HP	MCC17150	38-0007*	28 7/8 x 66 1/4		MCC14183
38-0011	22 7/8 x 60 1/2	DT440450	MCC606	38-0021*	29 1/4 x 73 1/4		
38-0026	22 7/8 x 60 1/4	1020H, 1020HP	MCC17149	38-0008*	29 3/8 x 73	L11002HRTGD	MCC14182
38-0044	23 x 27		MCC13580	38-0022*	29 1/2 x 72 3/4		
38-0045	23 x 29 1/2		MCC605	38-0019	32 x 78		
38-0014	23 x 46 3/8	1018, 11036	MCC250	38-0018	35 3/4 x 79 1/2		
38-0012	23 3/4 x 29 3/4	44020F01C		38-0020	35 7/8 x 78		
				38-0017	36 x 38		

*3 sides

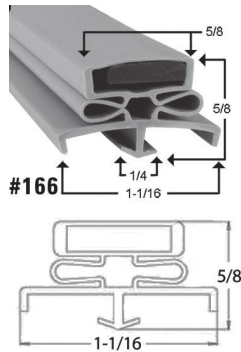

Glass Door Dart Style			
SKU	Dim. (Inches)	Commonly Fits Models	OEM Part #
38-0036	8 3/8 x 33 1/4	LBR4DST, LBS2DLT, LBS4DLT, LBS6DLT	MCC2GAD
38-0034	8 1/2 x 27 1/2	LBS-4DS-ST, LBS4DSST	MCC17910

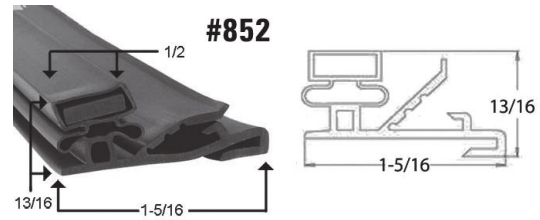
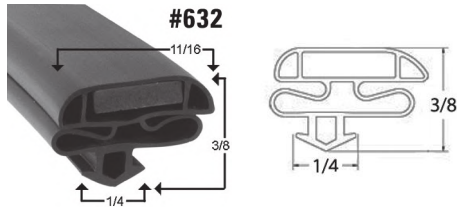

Glass Door

SKU	Dim. (Inches)	Commonly Fits Models	OEM Part #
38-0035	23 3/4 x 29 1/2	11020GDR01, 11045GDR01, 44045PGD01C	MCC15742
38-0051	23 3/4 x 59 3/8		MCC15743
38-0043	29 3/4 x 66 1/4		

Glass Door

SKU	Dimensions (Inches)
38-0003	24 1/2 x 30
38-0005	24 1/2 x 60 5/8

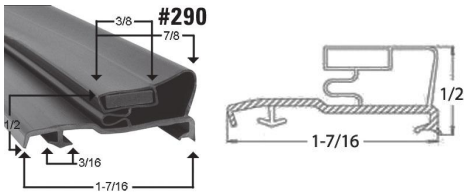

Glass Door

SKU	Dim. (Inches)	Commonly Fits Models	OEM Part #
38-0037	24 1/2 x 30	11045GDR01, 4402GD01C, 11020GDR01	MCC666
38-0004	24 5/8 x 60 3/4	11045FGD, 22045XPGD, 44020FGDC	MCC673

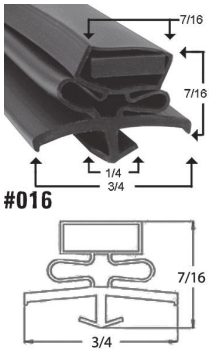

Glass Door

SKU	Dim. (Inches)	OEM Part #	SKU	Dim. (Inches)	SKU	Dim. (Inches)	OEM Part #
40-0006	12 7/8 x 16 1/8		40-0049	20 3/8 x 28	40-0005	24 3/8 x 25 1/8	87761
40-0068	13 1/8 x 16 1/8	87760	40-0059	21 x 30 3/4	40-0007	28 5/16 x 46	87759
40-0004	18 1/8 x 20 3/8	87799	40-0042	24 1/2 x 60	40-0060	28 3/4 x 46 7/8	
40-0008	18 1/8 x 20 3/8						

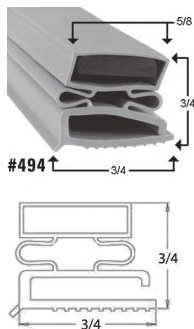

Screw In Style

SKU	Dim. (Inches)	Fits	OEM Part #	SKU	Dim. (Inches)	SKU	Dim. (Inches)	OEM Part #
40-0020*	20 1/8 x 22			40-0052	23 3/8 x 26 1/4	40-0041	31 1/2 x 80	
40-0097	21 x 22 1/4		854	40-0019**	31 x 79 1/4	40-0003	31 1/4 x 73 1/4	83667
40-0098	21 1/4 x 22 1/4		24582	40-0003	31 1/4 x 73 1/4	40-0099*	31 1/2 x 79 1/2	
40-0021	21 1/4 x 22 1/2			40-0034	31 1/4 x 76	40-0057	31 7/8 x 80 3/8	83671
40-0022	21 13/16 x 23 5/16	RC4B	25834			40-0045	37 1/2 x 80	
40-0036	23 1/4 x 26 1/4							

*3 sides
**3 sides, 4 corners

NOR-LAKE

NOR-LAKE

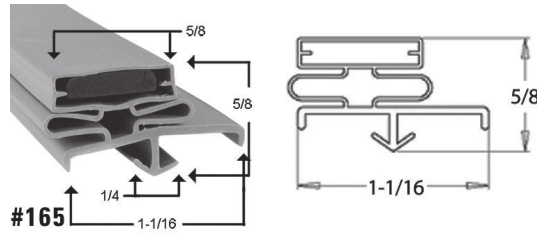

Dart Style

SKU	Dimensions (Inches)	Fits Models	OEM Part #	SKU	Dimensions (Inches)	Fits Models	OEM Part #
40-0055	10 1/2 x 22			40-0029	26 x 34 5/8		
40-0056	11 x 22			40-0011	26 x 59		28336
40-0016	12 1/2 x 25 1/2		3561	40-0067*	27 3/4 x 78 1/2	FTC01565-26L26L	37453
40-0001	12 1/2 x 25 1/2			40-0063**	28 3/8 x 60		
40-0047	13 1/8 x 16 1/8		113001	40-0012*	28 1/2 x 78 3/4		37454
40-0048	15 1/2 x 26 7/8			40-0044**	28 1/2 x 79-LH		
40-0058	19 1/2 x 22 3/8			40-0095**	28 1/2 x 79-RH		
40-0017	20 1/2 x 22		92507	40-0061**	28 5/8 x 59 7/8		
40-0046	20 1/2 x 28 1/2			40-0013**	28 3/4 x 67		28339
40-0030	20 1/4 x 27			40-0023*	28 7/8 x 67-LH		
40-0040	20 1/4 x 36 1/4			40-0097	28 7/8 x 67-RH		
40-0051	20 3/8 x 22 1/2		92635	40-0054**	28 x 67-RH	KODC46-CR-26	28338
40-0062	20 5/8 x 24 3/8		100127	40-0064*	29 x 69 1/2		
40-0028	23 1/4 x 27 3/8			40-0033**	32 3/8 x 67-RH		
40-0024	23 1/4 x 56 1/2		32764	40-0014	32 1/2 x 79		3723
40-0025	23 3/4 x 26			40-0035**	32 1/2 x 32 1/2		
40-0065	24 1/2 x 25 1/8	ZR122SMS-02	113002	40-0066	32 1/2 x 79		3721
40-0018	24 3/4 x 28 3/4		38049	40-0027*	32 1/2 x 80-RH		
40-0010	24 3/4 x 60 3/16		78860	40-0098*	32 1/2 x 80-LH		
40-0053	24 3/4 x 29			40-0031**	32 3/4 x 79-RH		
40-0039	24 3/4 x 29 3/4			40-0096**	32 3/4 x 79-LH		
40-0026	24 5/8 x 60 1/2			40-0015**	38 1/2 x 79-LH		3722
40-0038	25 x 60 1/2			40-0032**	38 1/2 x 79-RH		3722003724
40-0002	25 1/4 x 60 3/4						

*3 sides
**3 sides, inverted

Most Popular Sizes

PERLICK

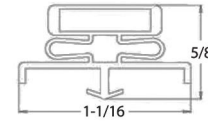
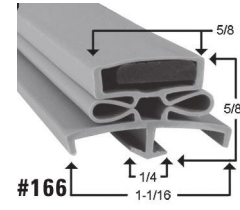
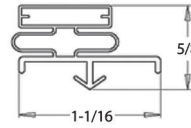
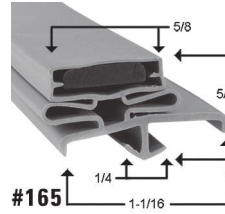
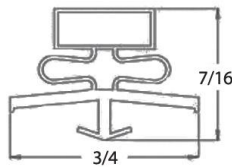

Dart Style

SKU	Dim. (Inches)	Fits Models	OEM Part #
42-0020	17 1/4 x 29 3/4		
42-0011	21 x 28 3/4		
42-0001	21 1/8 x 29 3/4	DP1KP, DR3KP	620851

Dart Style

SKU	Dim. (Inches)	Fits Models	OEM Part #
42-0013	17 3/4 x 29 1/4		66237--5
42-0015	21 1/4 x 27 7/8	HC24RS	66237--7
42-0016	21 5/8 x 29 1/4	BS32, BS84	66237--4

Dart Style

SKU	Dim. (Inches)
42-0021	37 3/4 x 82

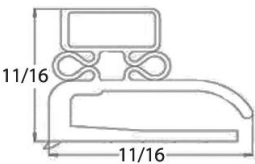
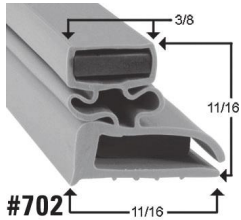

Screw In Style

SKU	Dim. (Inches)	Fits Models	OEM Part #	SKU	Dim. (Inches)	Fits Models	OEM Part #
42-0014	20 1/8 x 25 3/8		C5077	42-0007	20 x 32 5/8	1005A	C32046-1
42-0003	20 1/8 x 30 1/4		C18992-1	42-0005	22 x 32 1/2		C32047-1
42-0004	20 1/8 x 33		C32046-1	42-0009	22 1/2 x 32 3/4		
42-0008	20 x 25 1/2	C5077-SC-UL	C25166-1	42-0010	29 1/4 x 60		C25856-1
42-0002	20 x 25 1/4		C25166-1	42-0012	37 x 80 3/4		
42-0006	20 x 30 1/2	P5063SC	C18992-1				

RANDELL

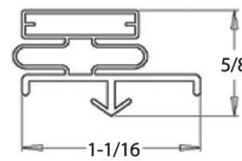
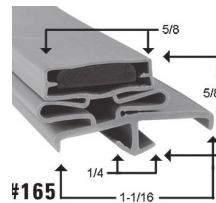

Dart Style

SKU	Dim. (Inches)	OEM Part #	SKU	Dim. (Inches)	Fits Models	OEM Part #	SKU	Dim. (Inches)	OEM Part #
46-0176	12 3/4 x 24 7/16	IN-GSK127S	46-0032	24 1/2 x 58	2020	IN-GSK320	46-0081	30 1/8 x 30 3/4	
46-0177	12 3/4 x 26 1/8	IN-GSK126	46-0178	26 1/8 x 27 7/8		IN-GSK315	46-0035	30 3/4 x 68 1/2	IN-GSK306
46-0036	12 7/8 x 24 1/4		46-0053	26 1/4 x 28			46-0054	30 7/8 x 68 3/8	
46-0074	12 7/8 x 26 1/4		46-0179	26 1/4 x 49 7/8		IN-GSK0118	46-0080	31 x 36	
46-0069	21 x 31	IN-GSK300	46-0030	26 1/4 x 58 1/8	2010F, 2010FP	IN-GSK325			
46-0037	24 1/4 x 27 7/8	IN-GSK310	46-0079	26 1/8 x 50					

PERLICK

RANDELL

RANDELL

RANDELL

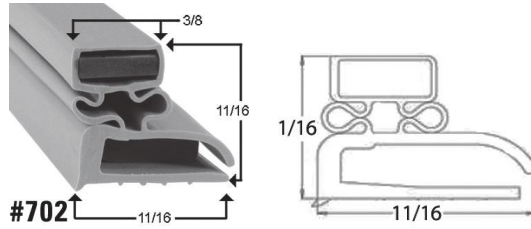

Screw In Style

SKU	Dimensions (Inches)	Fits Models	OEM Part #	SKU	Dimensions (Inches)	Fits Models	OEM Part #
46-0016	7 5/8 x 16	20078SCAM	IN-GSK106	46-0189	15 x 27 3/8		IN-GSK153
46-0007	7 5/8 x 24 3/8	20042R	IN-GSK195	46-0008	15 1/4 x 22 1/4	55350	IN-GSK145
46-0057	7 5/8 x 29 1/4	20042R	IN-GSK196	46-0013	15 1/4 x 24 1/4	9030K-7	IN-GSK143
46-0056	7 5/8 x 29 5/8			46-0190	15 1/2 x 57 3/4		IN-GSK316
46-0184	7 3/4 x 31 1/4		IN-GSK198	46-0191	15 3/4 x 24 1/4		IN-GSK146
46-0185	9 1/8 x 29 1/2		IN-GSK006	46-0026	16 1/4 x 18 1/2		IN-GSK147
46-0186	9 1/2 x 21 3/4		IN-GSK0001	46-0020	17 1/4 x 23 1/2	921028	
46-0014	9 7/8 x 15 1/4	52374AM	IN-GSK220	46-0192	17 5/8 x 19 3/4		IN-GSK001
46-0004	9 7/8 x 21 1/4	910092AM	IN-GSK225	46-0023	17 7/8 x 20 3/4	PH120E	IN-GSK120
46-0028	9 7/8 x 24 1/4		IN-GSK235	46-0193	20 1/4 x 23 1/4		IN-GSK002
46-0029	9 7/8 x 29 1/4		IN-GSK240	46-0005	21 1/4 x 22 1/4	55362AM	IN-GSK160
46-0071	9 x 17 5/16		IN-GSK205	46-0010	21 1/4 x 24 1/4	9030K-7	IN-GSK161
46-0019	9 x 23 1/4			46-0027	22 1/2 x 27 1/2	1010F, 1010	IN-GSK168A
46-0031	10 3/4 x 15 1/4		IN-GSK103	46-0022	22 1/2 x 56 1/2	1010F, 1010	IN-GSK169A
46-0033	10 3/4 x 21 1/4	9030K-7	IN-GSK104	46-0024	22 1/4 x 24 1/4	51362, 52362	IN-GSK270
46-0009	10 3/4 x 24 1/4	9030K-7	IN-GSK105	46-0011	23 1/2 x 58	1020FM	IN-GSK169
46-0055	11 1/2 x 29 1/4		IN-GSK142	46-0017	23 1/4 x 28 1/2	1010, 1010A	IN-GSK168
46-0066	11 1/4 x 17 1/4		IN-GSK125	46-0012	23 5/16 x 23 11/16	9045KM	IN-GSK165
46-0067	11 1/4 x 17 5/16			46-0006	24 x 24 1/4	9030K-7	
46-0001	11 1/4 x 22		IN-GSK110	46-0034	24 1/4 x 29 1/4	9404F-327M	IN-GSK290
46-0015	11 1/4 x 23 5/16		IN-GSK115	46-0082	24 3/8 x 27 1/4		
46-0187	11 7/8 x 24 1/4		IN-GSK116	46-0194	24 7/16 x 27 1/4		IN-GSK164
46-0025	12 1/4 x 23 1/4		IN-GSK140	46-0195	24 5/8 x 26 1/2		IN-GSK166
46-0021	12 1/8 x 21 1/4		IN-GSK135	46-0196	28 1/4 x 70 1/4		IN-GSK180
46-0188	14 3/4 x 19 5/8		IN-GSK003	46-0174	28 1/2 x 70 1/2		
				46-0197	29 x 29 3/4		IN-GSK308
				46-0198	29 3/4 x 35		IN-GSK307

Most Popular Sizes

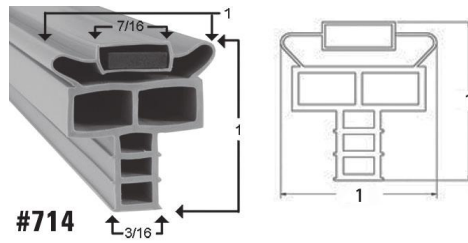

Push In Style

SKU	Dimensions (Inches)	Fits Models	OEM Part #	SKU	Dimensions (Inches)	Fits Models	OEM Part #
46-0175	7 1/8 x 42 1/4			46-0065	13 1/4 x 22	NC1048	IN-GSK1042
46-0073	7 3/16 x 16 3/4	20042R, 51350WPOM	IN-GSK1081	46-0063	13 5/16 x 16	9050KAM	IN-GSK1038
46-0199	7 3/16 x 42 5/16		IN-GSK0006	46-0061	13 5/16 x 24 3/4	94017M	IN-GSK1048
46-0038	7 5/16 x 24 7/8	20042R	IN-GSK1070	46-0209	15 1/2 x 16 9/16		IN-GSK1083
46-0039	7 5/16 x 29 7/8	20042R	IN-GSK1075	46-0210	15 1/2 x 24 9/16		IN-GSK1084
46-0096	8 1/4 x 24		IN-GSK1080	46-0048	15 5/8 x 24 1/4	52365WPRM-CFA	IN-GSK1020
46-0200	8 5/8 x 28 1/2		IN-GSK1100	46-0046	15 7/8 x 22 13/16	53372, 53360	IN-GSK1005
46-0201	9 9/16 x 29 11/16		IN-GSK0202	46-0211	16 1/8 x 20 5/8		IN-GSK0200
46-0059	9 3/4 x 22	NC1 53367	IN-GSK1043	46-0212	18 5/16 x 18 5/16		IN-GSK1115
46-0064	9 7/8 x 16	9050KAM	IN-GSK1039	46-0077	18 1/2 x 22 1/2		
46-0058	9 7/8 x 24 3/4	920028	IN-GSK1047	46-0072	18 1/2 x 24 1/4	8383N	IN-GSK9902
46-0202	10 3/16 x 15 9/16		IN-GSK1035	46-0213	18 9/16 x 41 1/2		IN-GSK9905
46-0092	10 3/16 x 18 9/32		IN-GSK1036	46-0094	18 5/8 x 22 5/8	BC5, BC5E	IN-GSK1006
46-0042	10 1/4 x 24 19/32	53396PRM	IN-GSK1045	46-0049	21 1/2 x 22 1/2	PH120E2	IN-GSK1010
46-0040	10 3/8 x 15 7/8		IN-GSK1035	46-0050	21 1/2 x 24 1/4	8260N	IN-GSK1025
46-0041	10 3/8 x 21 7/8	52387PRM	IN-GSK1040	46-0051	22 1/2 x 24 7/8	BC10E, 9412	IN-GSK1015
46-0043	10 3/8 x 29 7/8		IN-GSK1050	46-0075	24 1/8 x 27 1/2		IN-GSK0106
46-0002	10 3/4 x 21 3/4			46-0047	24 1/4 x 24 1/4	8148N	IN-GSK1030
46-0093	11 1/4 x 18 3/4	84111NM	IN-GSK9903	46-0097	24 1/4 x 29 5/8		IN-GSK1032
46-0044	11 5/16 x 21 3/4	8260N	IN-GSK1041	46-0216	24 1/4 x 41 3/8		IN-GSK9904
46-0045	11 5/16 x 24 3/4	8148N		46-0078	24 1/4 x 57 1/2		IN-GSK0111
46-0062	11 3/8 x 29 7/8	941232D-7		46-0076	25 15/16 x 57 1/2	2010DM	IN-GSK0113
46-0207	12 5/8 x 24 3/16		IN-GSK0117	46-0068	26 x 27 5/8	2010DE	IN-GSK0108
46-0208	12 5/8 x 25 7/8		IN-GSK0116				

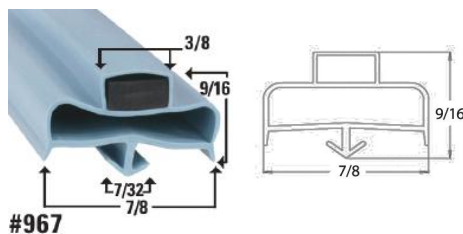

Dart Style

SKU	Dim. (Inches)
46-0170	9 x 29 1/2

LANDELL

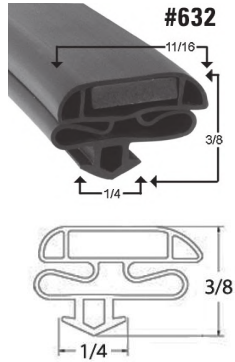

Low Profile Dart

SKU	Dim. (Inches)	Fits Models	OEM Part #	SKU	Dim. (Inches)	Fits Models	OEM Part #
46-0070	24 x 58 1/8	1011, 1011F	IN-GSK302A	46-0182	24 3/8 x 27 15/16		IN-GSK2021S
46-0095	24 3/8 x 58 1/16			46-0052	26 1/8 x 57 7/8	HDDOR2011	IN-GSK2011
46-0171	24 1/4 x 27 1/4			46-0173	26 3/4 x 27 7/8		
46-0172	24 1/4 x 28			46-0183	26 3/8 x 27 15/16		IN-GSK2011S
46-0181	24 5/16 x 27 5/8		IN-GSK301A	46-0190	26 3/8 x 58 1/16		IN-GSK2011

SCHOTT GEMTRON

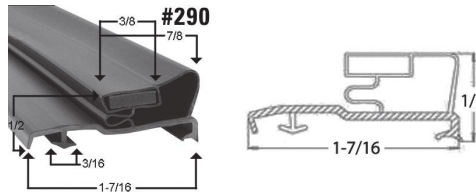

Low Profile Dart

SKU	Dim. (Inches)	OEM Part #	SKU	Dim. (Inches)	OEM Part #	SKU	Dim. (Inches)	OEM Part #
82-0085	26 3/8 x 71 1/8	3M-0016173	82-0104	29 1/4 x 63 1/16	3M-0016137	82-0123	29 15/16 x 62 1/2	3M-0016112
82-0086	27 13/16 x 45 7/8	3M-0016072	82-0105	29 1/4 x 64 7/8	3M-0016019	82-0124	29 15/16 x 62 3/4	3M-0016056
82-0087	27 13/16 x 64 3/4	3M-0016035	82-0106	29 1/4 x 64 7/8	3M-0016139	82-0125	29 15/16 x 62 5/8	3M-0016021
82-0088	27 13/16 x 65 1/8	3M-0016152	82-0107	29 1/4 x 65 11/16	3M-0016178	82-0126	29 15/16 x 63 1/16	3M-0016129
82-0089	27 13/16 x 72 3/4	3M-0016024	82-0108	29 1/4 x 66 3/8	3M-0016016	82-0127	29 15/16 x 64 15/16	3M-0016111
82-0090	27 13/16 x 73 1/8	3M-0016128	82-0109	29 1/4 x 66 7/8	3M-0016141	82-0128	29 15/16 x 64 3/4	3M-0016028
82-0091	27 13/16 x 76 3/4	3M-0016032	82-0110	29 1/4 x 71 3/8	3M-0016156	82-0129	29 15/16 x 65 1/8	3M-0016126
82-0092	27 13/16 x 77 1/8	3M-0016143	82-0111	29 1/4 x 71 5/16	3M-0016170	82-0130	29 15/16 x 66 7/8	3M-0016008
82-0093	28 1/16 x 48 1/16	3M-0016116	82-0112	29 1/8 x 60 3/16	3M-0016010	82-0131	29 15/16 x 66 7/8	3M-0016132
82-0094	28 1/16 x 50 1/16	3M-0016089	82-0113	29 1/8 x 64 13/16	3M-0016004	82-0132	29 15/16 x 67 13/16	3M-0016039
82-0095	28 x 17 1/16	3M-0016192	82-0114	29 13/16 x 71 7/8	3M-0016060	82-0133	29 15/16 x 68 3/16	3M-0016151
82-0096	28 x 43 1/2	3M-0016191	82-0115	29 15/16 x 27 3/4	3M-0016054	82-0134	29 15/16 x 70 3/4	3M-0016033
82-0097	28 x 60 7/8	3M-0016190	82-0116	29 15/16 x 28 1/8	3M-0016175	82-0135	29 15/16 x 71 1/8	3M-0016150
82-0098	29 1/2 x 55 3/4	3M-0016183	82-0117	29 15/16 x 33 3/4	3M-0016062	82-0136	29 15/16 x 71 7/8	3M-0016036
82-0099	29 1/2 x 67 13/16	3M-0016045	82-0118	29 15/16 x 34 1/8	3M-0016154	82-0137	29 15/16 x 71 7/8	3M-0016169
82-0100	29 1/4 x 55 5/8	3M-0016177	82-0119	29 15/16 x 58 7/8	3M-0016138	82-0138	29 15/16 x 72 3/4	3M-0016017
82-0101	29 1/4 x 59 15/16	3M-0016020	82-0120	29 15/16 x 60 13/16	3M-0016052	82-0139	29 15/16 x 72 3/8	3M-0016038
82-0102	29 1/4 x 60 3/8	3M-0016140	82-0121	29 15/16 x 61 7/8	3M-0016135	82-0140	29 15/16 x 73 1/8	3M-0016123
82-0103	29 1/4 x 62 1/16	3M-0016018	82-0122	29 15/16 x 62 1/2	3M-0016048	82-0141	29 15/16 x 76 3/4	3M-0016025

SCHOTT GEMTRON

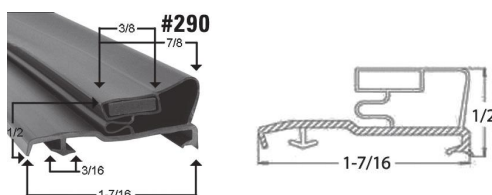

Low Profile Dart

SKU	Dim. (Inches)	OEM Part #	SKU	Dim. (Inches)	OEM Part #	SKU	Dim. (Inches)	OEM Part #
82-0001	14 5/16 x 22 1/8	3M-0016186	82-0029	23 13/16 x 33 7/8	3M-0016007	82-0057	23 5/16 x 50 1/16	3M-0016078
82-0002	15 13/16 x 27 11/16	3M-0016189	82-0030	23 13/16 x 34 1/8	3M-0016148	82-0058	23 5/16 x 50 9/16	3M-0016119
82-0003	16 7/16 x 19 15/16	3M-0016131	82-0031	23 13/16 x 45 7/8	3M-0016046	82-0059	23 5/16 x 52 9/16	3M-0016097
82-0004	17 3/4 x 65 7/16	3M-0016041	82-0032	23 13/16 x 46 1/8	3M-0016147	82-0060	23 5/16 x 54 1/2	3M-0016117
82-0005	19 15/16 x 52 9/16	3M-0016099	82-0033	23 13/16 x 64 3/4	3M-0016029	82-0061	23 5/16 x 56 9/16	3M-0016077
82-0006	20 13/16 x 52 13/16	3M-0016196	82-0034	23 13/16 x 65 1/8	3M-0016136	82-0062	23 5/16 x 57 1/2	3M-0016107
82-0007	21 13/16 x 65 1/8	3M-0016146	82-0035	23 13/16 x 68 1/16	3M-0016014	82-0063	23 5/16 x 61 1/4	
82-0008	22 1/16 x 61 3/4	3M-0016106	82-0036	23 13/16 x 70 3/4	3M-0016034	82-0064	23 5/16 x 62 5/8	3M-0016061
82-0009	22 11/16 x 61 3/4	3M-0016114	82-0037	23 13/16 x 71 1/8	3M-0016149	82-0065	23 5/16 x 63 1/16	3M-0016157
82-0010	22 13/16 x 45 7/8	3M-0016185	82-0038	23 13/16 x 72 3/4	3M-0016022	82-0066	23 5/16 x 66 13/16	3M-0016080
82-0011	22 13/16 x 76 3/4	3M-0016055	82-0039	23 13/16 x 73 1/8	3M-0016133	82-0067	23 5/16 x 67 13/16	3M-0016042
82-0012	22 15/16 x 56 9/16	3M-0016094	82-0040	23 13/16 x 76 3/4	3M-0016047	82-0068	23 5/16 x 71 9/16	3M-0016100
82-0013	22 7/8 x 67 13/16	3M-0016044	82-0041	23 15/16 x 33 5/16	3M-0016153	82-0069	23 x 52	3M-0016065
82-0014	23 1/16 x 52 9/16	3M-0016083	82-0042	23 15/16 x 50 1/16	3M-0016104	82-0070	23 x 52 1/16	3M-0016003
82-0015	23 1/16 x 60 1/16	3M-0016082	82-0043	23 15/16 x 68 9/16	3M-0016103	82-0071	24 1/8 x 57 3/4	3M-0016005
82-0016	23 1/16 x 60 1/16	3M-0016085	82-0044	23 3/16 x 50 1/16	3M-0016090	82-0072	25 1/4 x 61 1/4	3M-0016027
82-0017	23 1/16 x 71 9/16		82-0045	23 3/16 x 56 9/16	3M-0016194	82-0073	25 15/16 x 27 11/16	3M-0016074
82-0018	23 1/4 x 48 1/16	3M-0016084	82-0046	23 3/16 x 62 3/4	3M-0016053	82-0074	25 15/16 x 34 1/8	3M-0016167
82-0019	23 1/4 x 52 1/16	3M-0016081	82-0047	23 3/8 x 48	3M-0016066	82-0075	25 15/16 x 62 1/2	3M-0016001
82-0020	23 1/4 x 52 9/16	3M-0016086	82-0048	23 3/8 x 54 9/16	3M-0016075	82-0076	25 15/16 x 64 3/4	3M-0016030
82-0021	23 1/4 x 54 5/16	3M-0016187	82-0049	23 3/8 x 54 9/16	3M-0016088	82-0077	25 15/16 x 65 1/8	3M-0016134
82-0022	23 1/4 x 72 3/4	3M-0016026	82-0050	23 3/8 x 56 9/16	3M-0016087	82-0078	25 15/16 x 71 1/2	3M-0016058
82-0023	23 1/8 x 56 9/16	3M-0016095	82-0051	23 3/8 x 59 15/16	3M-0016009	82-0079	25 15/16 x 72 3/4	3M-0016023
82-0024	23 1/8 x 71 9/16	3M-0016108	82-0052	23 3/8 x 60 1/16	3M-0016067	82-0080	25 15/16 x 73 1/8	3M-0016122
82-0025	23 13/16 x 21 13/16	3M-0016064	82-0053	23 5/16 x 33 9/16		82-0081	25 15/16 x 76 3/4	3M-0016031
82-0026	23 13/16 x 27 3/4	3M-0016059	82-0054	23 5/16 x 39 9/16		82-0082	25 15/16 x 77 1/8	3M-0016142
82-0027	23 13/16 x 33 3/4	3M-0016049	82-0055	23 5/16 x 46 1/16	3M-0016120	82-0083	25 7/8 x 71 15/16	3M-0016193
82-0028	23 13/16 x 33 3/4	3M-0016105	82-0056	23 5/16 x 48 1/16	3M-0016110	82-0084	25 9/16 x 62 1/8	3M-0016172

SCHOTT GEMTRON

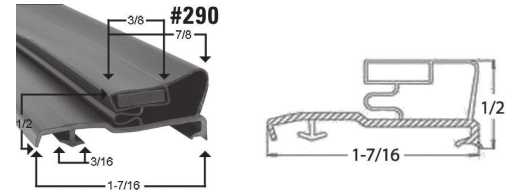
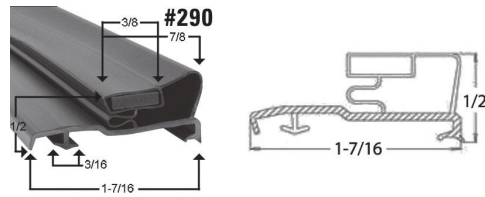

Low Profile Dart

SKU	Dim. (Inches)	OEM Part #	SKU	Dim. (Inches)	OEM Part #
82-0142	29 15/16 x 76 9/16	3M-0016002	82-0170	34 13/16 x 52 1/2	3M-0016195
82-0143	29 15/16 x 77 1/8	3M-0016127	82-0171	34 13/16 x 56 9/16	3M-0016012
82-0144	29 15/16 x 79 3/8	3M-0016124	82-0172	35 1/16 x 50 1/16	3M-0016102
82-0145	29 15/16 x 82 3/8	3M-0016164	82-0173	35 1/16 x 52 9/16	3M-0016098
82-0146	29 5/16 x 25	3M-0016043	82-0174	35 1/16 x 54 9/16	3M-0016079
82-0147	29 7/8 x 54 3/4	3M-0016181	82-0175	35 1/4 x 52 7/16	3M-0016069
82-0148	29 7/8 x 58 3/4	3M-0016176	82-0176	35 1/4 x 62 3/8	3M-0016051
82-0149	29 7/8 x 61 1/8	3M-0016182	82-0177	35 1/4 x 66 3/8	3M-0016037
82-0150	29 7/8 x 61 15/16	3M-0016180	82-0178	35 1/4 x 66 7/8	3M-0016166
82-0151	30 1/8 x 61 1/8	3M-0016184	82-0179	35 1/4 x 69 1/2	3M-0016168
82-0152	30 5/8 x 62 1/8	3M-0016171	82-0180	35 1/4 x 70 11/16	3M-0016174
82-0153	30 x 61 3/8	3M-0016188	82-0181	35 1/8 x 56 9/16	
82-0154	30 x 71 15/16	3M-0016006	82-0182	35 3/16 x 46 1/16	3M-0016121
82-0155	30 x 80 1/16	3M-0016179	82-0183	35 3/16 x 54 1/2	3M-0016071
82-0156	31 1/4 x 52 9/16	3M-0016113	82-0184	35 3/16 x 56 9/16	3M-0016076
82-0157	31 1/4 x 54 9/16	3M-0016073	82-0185	35 3/4 x 68 1/16	3M-0016015
82-0158	31 1/4 x 59 15/16	3M-0016093	82-0186	35 3/8 x 59 15/16	3M-0016092
82-0159	31 1/4 x 62 3/8	3M-0016050	82-0187	35 3/8 x 63 15/16	3M-0016109
82-0160	31 1/4 x 66 3/8	3M-0016040	82-0188	35 5/16 x 52	3M-0016063
82-0161	31 1/4 x 66 7/8	3M-0016165	82-0189	35 7/16 x 64 3/4	3M-0016011
82-0162	31 1/8 x 54 1/2	3M-0016070	82-0190	35 7/16 x 72 3/4	3M-0016096
82-0163	31 1/8 x 56 9/16	3M-0016118	82-0191	35 7/16 x 73 1/8	3M-0016144
82-0164	31 3/16 x 46 1/16	3M-0016115	82-0192	35 7/16 x 77 3/8	3M-0016159
82-0165	31 3/16 x 50 1/16	3M-0016091	82-0193	35 7/16 x 78 3/8	3M-0016160
82-0166	31 3/16 x 52 7/16	3M-0016068	82-0194	35 7/16 x 79 1/8	3M-0016057
82-0167	32 3/8 x 62 7/8	3M-0016158	82-0195	35 7/16 x 79 3/8	3M-0016125
82-0168	32 5/16 x 63 1/16	3M-0016130	82-0196	35 7/16 x 82 3/8	3M-0016145
82-0169	34 13/16 x 48 1/16	3M-0016013	82-0197	36 1/16 x 68 9/16	3M-0016101

Low Profile Dart

SKU	Dim. (Inches)	OEM Part #
82-0198	37 7/16 x 67 1/16	3M-0016162
82-0199	37 x 48 3/4	3M-0016155
82-0200	47 1/16 x 79 3/8	3M-0016161
82-0201	60 5/16 x 65 1/8	3M-0016163
82-0202	28 x 17 1/16	3M-0016197
82-0203	25 7/8 x 71 15/16	3M-0016198
82-0204	23 3/16 x 56 9/16	3M-0016199
82-0205	34 13/16 x 52 1/2	3M-0016200
82-0206	20 13/16 x 52 13/16	3M-0016201

Top Hinge 3 Wire



SKU	Part #
82-0303	44QLASM21-1 HPBK*

Top Hinge Pin no leads or wires



SKU	Part #
82-0304	44QLASM22 BK*

SCHOTT GEMTRON

Torque Adjuster



SKU	Color	Part #
82-0300	Black	44QLASM20-BK*

SKU	Color	Part #
82-0301	Silver	44QLASM20*

Hinge Pin Receptacle Single Three Wire



SKU	Part #
82-0305	44QL30-2 HP*

Hinge Pin Receptacle Double Three Wire



SKU	Color	Part #
82-0306	Black	44QL28-2 HP*

Hold Open Bushing a.k.a. "Sleeve"



SKU	Part #
82-0307	44PUR021-35*

Clover Leaf Plug a.k.a. "Hole Plug"



SKU	Part #
82-0308	44QL36*

Hinge Pin Filler Plug a.k.a. "Safety Plug"



SKU	Part #
82-0309	44QL32*

29" Torque Rod



SKU	Part #
82-0302	44QLASM1*

Electrical Access Cover



SKU	Part #
82-0310	44QL34*

*Aftermarket

SILVER KING

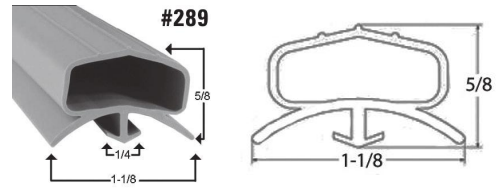
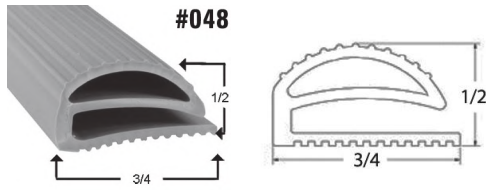

Compression

SKU	Dimensions (Inches)	OEM Part #
50-0006	13 3/4 x 26 1/2	10310--07
50-0005	25 x 26 1/2	20410-DOOR GSK
50-0012	26 3/8 x 35 3/4	

Compression Dart Style

SKU	Dimensions	OEM Part #	SKU	Dimensions	OEM Part #
50-0007	10 x 18 1/2	62806	50-0028	17 x 35 3/8	
50-0015	13 5/8 x 17		50-0008	24 5/8 x 26 1/4	10310--12
50-0018	15 x 25 3/8		50-0029	25 3/8 x 36 3/4	
50-0016	17 x 24 1/2				

Most Popular Sizes

Santoprene Gasket

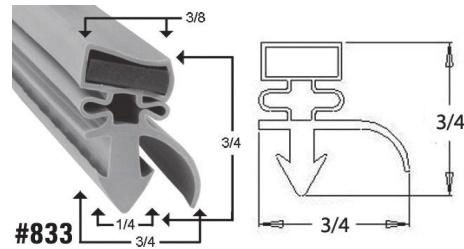

Dart Style

SKU	Dimensions (Inches)	Fits Models	OEM Part #	SKU	Dimensions (Inches)	Fits Models	OEM Part #
50-0024	6 7/8 x 27 1/2			50-0037	15 9/16 x 28 1/2		10310--53
50-0025	6 7/8 x 40 1/4			50-0013	18 1/2 x 27 1/4	SKFS, SKSR	42014
50-0027	8 1/4 x 14 1/8			50-0009	20 3/8 x 34 5/8		
50-0023	8 1/8 x 27 5/8	SKRCB84	10310--55	50-0017*	22 1/2 x 24 1/4		
50-0034	8 1/4 x 40 5/8		10310--56	50-0019	22 1/2 x 26 3/4	SKR24	10310--39
50-0031	8 3/8 x 40 5/8	SKRCB84		50-0004	22 3/8 x 23 3/8		
50-0035	8 1/2 x 27 1/4		42014	50-0010	23 1/8 x 27 1/8	SKF488	10310--33
50-0020	10 x 28 1/2			50-0003	23 x 28 1/8		10310--06
50-0026	13 x 25 1/4	SKPZ27D	10310--51	50-0011	25 5/8 x 27	SKP278	10310--44
50-0022	13 x 28 1/2			50-0014	25 5/8 x 27 1/8	SKR27	10310--32
50-0036	13 3/4 x 26 3/4		10310--14	50-0038	26 1/4 x 27 1/8		
50-0001	14 x 26 3/4			50-0002	26 3/4 x 28 1/8	SKSB10	10310--04
50-0021	15 1/2 x 28 1/2			50-0032	27 x 28 3/4	SKP60	10310--34

*Hinge Side Hollow

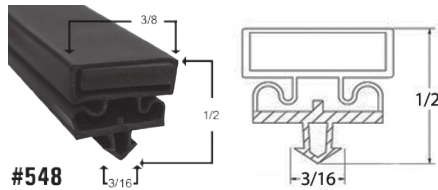

Dart Style

SKU	Dim. (Inches)	OEM Part #	SKU	Dim. (Inches)	OEM Part #	SKU	Dim. (Inches)	OEM Part #
53-0030	22 x 71		53-0037	25 x 71 1/8		53-0045	29 x 79	
53-0031	22 1/4 x 61 3/4		53-0038	25 1/4 x 78 3/4		53-0046*	29 x 79 3/4	
53-0032	22 5/16 x 59 7/8		53-0039	25 5/8 x 51		53-0047	29 1/2 x 65 1/2	
53-0051	23 x 62 1/4	5595BCK1	53-0040	25 5/8 x 63		53-0048	29 3/4 x 63 1/4	
53-0033	23 x 62 3/4		53-0041	25 3/4 x 71 1/8		53-0019	29 3/4 x 79 3/4	5595BCR2
53-0034	23 x 71 3/4		53-0054	28 3/4 x 78 1/4	5595BSG3	53-0020	29 3/4 x 80	5595BCG3
53-0052	23 1/2 x 28 1/8	5595BCC2	53-0042	28 7/8 x 71 1/8		53-0017	29 7/8 x 71 3/4	5595BCG2
53-0053	23 1/2 x 72	5595BCS3	53-0043	29 x 62		53-0018	35 3/4 x 79	5595BCR3
53-0035	25 x 61 5/8		53-0044	29 x 64 5/8		53-0049	35 x 79 1/8	
53-0036	25 x 71					53-0050	35 3/4 x 79 3/4	

***3 sides**

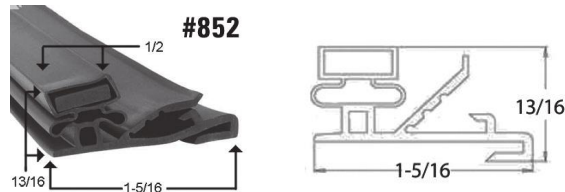

Classic, 20/20, & Freezer Doors Prior to 06/1998

SKU	Dim. (Inches)	OEM Part	SKU	Dim. (Inches)	OEM Part	SKU	Dim. (Inches)	OEM Part
53-0030	23 1/8 x 62 3/4- LH		53-0013	25 3/4 x 79 3/4- RH		53-0021	29 3/4 x 62 3/4- LH	
53-0003	23 1/8 x 62 3/4- RH		53-0028	25 3/4 x 79 3/4- LH		53-0009	29 3/4 x 65 3/4- RH	5769BG1L
53-0002	23 1/4 x 54 1/4- LH		53-0052	26 x 63- RH		53-0011	29 3/4 x 79 3/4	
53-0007	23 1/4 x 71 3/4- RH		53-0024	26 x 63- LH	5595BCK1	53-0027	29 3/4 x 79 3/4- LH	
53-0006	23 3/8 x 71 3/4- LH	5769BS3R	53-0004	26 x 63- RH		53-0010	29 5/8 x 71 1/2- LH	3G2
53-0016	24 5/8 x 31 1/4- RH		53-0001	26 3/8 x 48 3/8		53-0012	34 x 79 1/2	
53-0022	24 5/8 x 31 1/4- LH	5595BCS3	53-0025	29 3/4 x 65 3/4- LH	5595BCG1	53-0029	35 3/4 x 79 3/4- LH	
53-0008	25 3/4 x 71 3/4- LH		53-0015	27 1/8 x 61 5/16- RH		53-0014	35 3/4 x 79 3/4- RH	
53-0023	25 3/4 x 71 3/4- RH	5595BSG2	53-0005	29 3/4 x 62 3/4- RH				
			53-0026	29 5/8 x 71 1/2- RH				

If dimension notes- LH or -RH, the gasket is made for equipment that has the hinge on the left hand side (-LH) or the right hand side (-RH)

STYLELINE

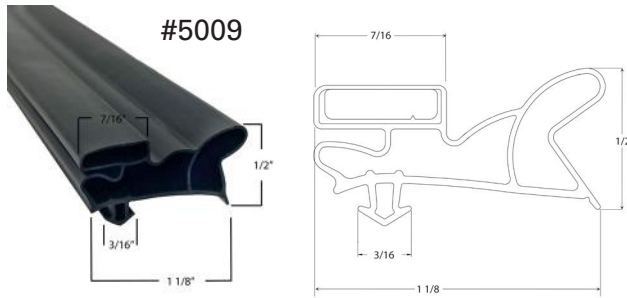

Bottom Hinge Repair Kit 5548 STYLELINE

SKU	Part #
53-0070	5548-KIT



Dart Style- Profile #5009

SKU	Dimensions (Inches)	OEM Part #	SKU	Dimensions (Inches)	OEM Part #
53-0055	65 13/16 x 29 3/8	8616BSG1	53-0061	71 13/16 x 25 7/16	8616BSS2
53-0056	71 13/16 x 29 3/8	8616BSG2	53-0062	71 13/16 x 22 5/8	8616BSS3
53-0057	79 13/16 x 29 3/8	8616BSG3	53-0063	79 13/16 x 25 7/16	8616BSS5
53-0058	62 15/16 x 22 5/8	8616BSK1	53-0064	79 13/16 x 36 3/16	8616BSR3
53-0059	62 15/16 x 25 7/16	8616BSK2	53-0065	84 x 36 3/16	8616BSR5
53-0060	62 15/16 x 29 3/8	8616BSK3	53-0066	65 1/4 x 29 3/8	8616BSMN

Top Hinge Repair Kit 2907-5705 STYLELINE

SKU	Part #
53-0071	2907
53-0072	5705



Bottom Hinge Repair Kit 2908 STYLELINE

SKU	Part #
53-0073	2908



Bottom Hinge Repair Kit 9360 STYLELINE

SKU	Part #
53-0069	9360-KIT



Offset Handle Kit Combo STYLELINE



SKU	Color	Part #
53-0067	Bright Silver	9455S
53-0068	Bright Black	9455L
53-0074	Satin Black	5680B
53-0075	Satin Black	9455B
53-0076	Satin Black	5678B

THERMO-KOOL

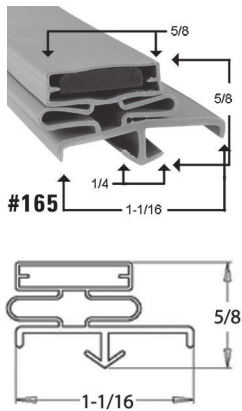

Dart Style		
SKU	Dimensions (Inches)	OEM Part #
55-0010*	31 7/8 x 81	3181
55-0003*	32 x 81 1/2	
55-0011*	35 5/8 x 80 5/8	3581
55-0001*	36 x 81 1/2	511500
55-0012*	37 5/8 x 81 1/8	3781
55-0002*	37 7/8 x 81 1/2	511700
55-0004*	48 3/4 x 87 3/4	
55-0013*	50 x 80 3/4	4981

*3 sides



Door Sweep	
SKU	Length
55-0005	34
55-0006	36
55-0007	38
55-0008	41 1/2
55-0009	42 5/8

TRAULSEN

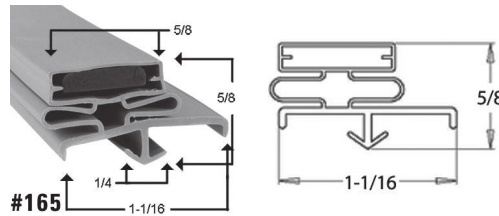

Dart Style							
SKU	Dimensions (Inches)	Fits Models	OEM Part #	SKU	Dimensions (Inches)	Fits Models	OEM Part #
56-0058	7 x 23 1/4			56-0028	22 5/8 x 59 5/8	G10000H1	
56-0115	7 1/4 x 23 3/8	UL1HT	60005-01	56-0047	22 3/4 x 59 3/4	RHT232WUTFHS	60059-00
56-0129	7 5/16 x 28 3/8			56-0061	22 13/16 x 29 5/8	RHT132WPUT-HHS	60060-00
56-0130	7 5/16 x 41 5/16			56-0133	23 1/4 x 23 1/2	UL3HT	60005-00
56-0164	7 7/16 x 16 1/2		60176-02	56-0023	23 1/2 x 23 3/4		
56-0165	7 7/16 x 41 13/16		60176-04	56-0169	23 3/4 x 29 3/4		32289
56-0166	8 3/8 x 25 3/8		60176-01	56-0170	23 3/4 x 59 3/4		32290
56-0128	8 1/2 x 30	TE048HT	60176-03	56-0146	25 x 27	RAC37	60142-00
56-0131	11 1/2 x 23 3/8		60005-03	56-0171	27 3/4 x 59 1/2		60105
56-0001	13 9/16 x 61 3/8			56-0172	28 1/8 x 29 1/2		X0003
56-0132	14 3/8 x 23 1/2	UL3HT		56-0070	28 1/4 x 29 1/2		60274
56-0118	16 1/2 x 22 3/8	VPS48S	60070-00	56-0073	28 1/2 x 59 3/4		
56-0113	21 5/8 x 59 3/4	G20010AKM	09503-00	56-0174	29 1/4 x 68 3/4		32291
56-0072	22 1/2 x 29 1/4	AHF132WPHHS	60084-00				
56-0167	22 1/2 x 59 1/4		60256-00				
56-0074	22 5/8 x 59 3/4		60083-00				

*3 sides

THERMO-KOOL

TRAULSEN

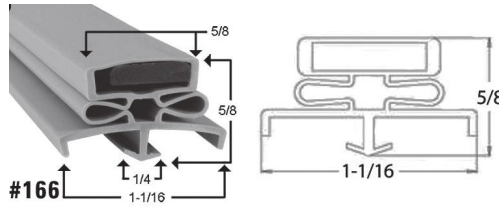

Centered Magnet Dart Style

SKU	Dimensions (Inches)	Fits Models	OEM Part #	SKU	Dimensions (Inches)	Fits Models	OEM Part #
56-0175	6 7/8 x 28		42737	56-0182	22 1/2 x 22 1/2		60050
56-0039	7 1/8 x 23 1/2			56-0066	22 1/2 x 22 5/8	VPS90S-ZCF01	
56-0054	7 1/8 x 28 1/4	TUC332N	42737	56-0048	22 3/4 x 29 1/2	G20000	41222
56-0117	8 3/8 x 25 1/2	TE072HT	60272-01	56-0148	23 1/4 x 25 3/4	TU072HT	60197
56-0033	9 1/2 x 23 5/8			56-0183	23 1/2 x 23 1/2		16970
56-0040	11 1/2 x 23 1/2	RFC232W	39392	56-0112	23 1/2 x 29 1/2	AHT132WREHHG	9500
56-0060	12 7/8 x 21 1/2		39394	56-0116	23 1/2 x 59 1/2	RLT132WUT	61097
56-0176	13 9/16 x 61 3/8		43565	56-0024	23 3/4 x 41 7/8	URDT224DUT	33096
56-0067	14 1/2 x 23 5/8			56-0059	23 5/8 x 55 3/4		
56-0137	14 5/8 x 28 1/4			56-0068	25 x 26 1/8	UHT60-ZCF01	60287
56-0138	14 7/8 x 23 3/4			56-0052	28 1/4 x 29 3/4		
56-0177	18 1/8 x 43 3/4		37345	56-0184*	28 7/8 x 67 3/8		60085
56-0031	19 1/2 x 29 1/2		35254	56-0141	29 1/4 x 29 1/2		
56-0053	19 5/8 x 59 3/4			56-0029	29 1/4 x 31 1/2		
56-0178	20 x 23 1/4		41633	56-0056	29 1/4 x 32		
56-0114	20 5/16 x 26 5/16	UHT48LR	60090	56-0149*	29 1/4 x 67 1/2	RIH232LFHS	16473
56-0055	20 1/2 x 29 1/2	AHT132DUT	39080	56-0032	29 1/4 x 69 1/2		29147
56-0143*	20 1/2 x 68			56-0147*	29 1/4 x 73 5/8	RRI232H	37698
56-0069	20 5/8 x 23 1/2		35355	56-0019*	29 1/2 x 68	RR1232 LUT	
56-0050	20 3/4 x 23 5/8	UC27HT		56-0062	29 1/2 x 69 1/2		
56-0063	20 3/4 x 59 7/8	HT132DUT		56-0185	29 1/2 x 32		17339
56-0139	21 1/2 x 23 1/2	TE048HT	9504	56-0022*	29 1/2 x 72		
56-0044	21 1/2 x 26 1/2			56-0186*	29 1/2 x 73		37698
56-0111	21 1/2 x 29 1/2	ADT332N	9502, 9500	56-0187*	30 x 67 5/8		21318
56-0110	21 1/2 x 59 1/2	ADT332N	9503, 9501	56-0142	31 x 36	RBC10024	
56-0140	21 5/8 x 29 1/2						

*3 Sides

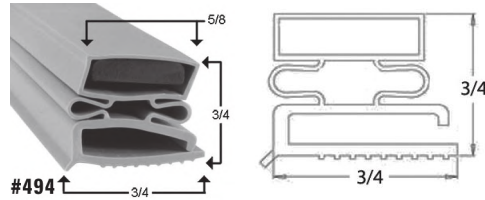

Screw Mount

SKU	Dimensions (Inches)	OEM Part #	SKU	Dimensions (Inches)	Fits Models	OEM Part #
56-0188	6 7/8 x 23 1/2	21461	56-0196	23 1/2 x 29 1/2		4503
56-0189	8 1/4 x 15 3/8	62447	56-0197	23 1/2 x 59 1/2		4505
56-0190	11 1/2 x 23 1/2	19775	56-0071	25 1/2 x 56 1/2	RAC37	60143
56-0191	12 3/4 x 21 3/8	18749	56-0153	27 1/2 x 27 1/2		43493
56-0192	14 3/8 x 23 3/8	19889	56-0064	27 1/2 x 56 1/2		60024
56-0193	21 1/2 x 23 1/2	4543	56-0198*	28 x 66		7841
56-0002	21 1/2 x 29 3/8		56-0011*	28 x 72		4601
56-0194	21 1/2 x 29 1/2	4507	56-0199*	29 x 67 3/4		14169
56-0195	21 1/2 x 59 1/2	4508	56-0200*	29 1/2 x 72 1/2		18083
56-0003	23 3/8 x 29 3/8		56-0201*	29 x 73 5/8		39209
			56-0202*	29 x 75 1/2		34629

***3 Sides**

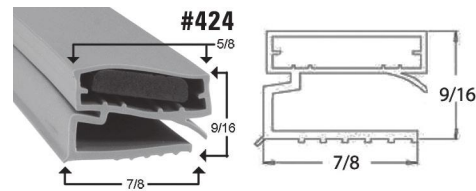
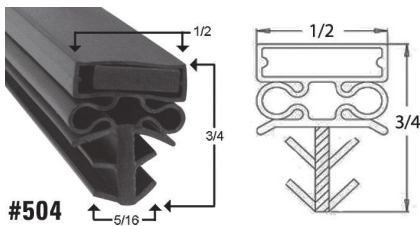

Glass Door

SKU	Dimensions (Inches)	Fits Models	OEM Part #
56-0057	22 1/2 x 59 1/2	G11011	41448-02
56-0134	22 3/4 x 29 1/2	G21000	41448-01
56-0136	23 1/2 x 29 1/2	60362	42090-01
56-0043	23 1/2 x 59 3/4	G11010	42090-02

3 Sided Screw In

SKU	Dim. (Inches)	Hinge Side	SKU	Dim. (Inches)	Hinge Side
56-0158	26 1/2 x 75 1/4	RH	56-0161	33 1/2 x 73 1/2	LH
56-0159	26 1/2 x 75 1/4	LH	56-0162	33 5/8 x 75 3/4	RH
56-0160	33 1/2 x 73 1/2	RH	56-0163	33 5/8 x 75 3/4	LH

***3 sides**

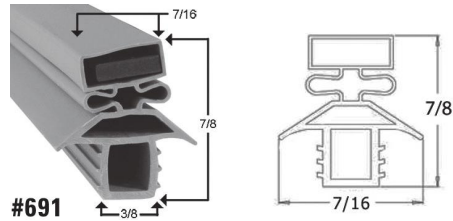

Push In

SKU	Dimensions (Inches)	Fits Models	OEM Part	SKU	Dimensions (Inches)	Fits Models	OEM Part
56-0120	7 x 23 1/2	RUL232W	37204	56-0004	17 3/4 x 43 1/2		
56-0121	7 1/8 x 28 1/8	TUC332N		56-0145	18 7/32 x 43 23/32	URS36DT	37505
56-0006	8 x 13 1/4			56-0207	19 5/8 x 29 5/8		35309
56-0007	8 x 17 1/4			56-0208	19 5/8 x 59 3/4		45401
56-0005	8 1/4 x 19 3/8		39254	56-0025	19 3/4 x 29 3/4		
56-0144	8 1/2 x 13 23/32	URS36DT	37516	56-0126	19 3/4 x 59 3/4		
56-0051	8 1/2 x 15 5/8	URDT224DUT	36858	56-0036	20 5/8 x 23 3/4	ARF	30515
56-0122	8 1/2 x 18 1/4	URS36DT	37517	56-0210	20 1/2 x 29 1/2		38232
56-0046	8 1/2 x 23 5/8	URDT224DUT	36850	56-0037	20 5/8 x 29 1/2		
56-0123	9 1/2 x 23 5/8		37935	56-0042	20 3/4 x 59 5/8	RHT232WUTFHS	38157
56-0124	11 1/2 x 23 1/2	TUC232NSC		56-0209	21 1/8 x 32 1/8		37856
56-0204	11 5/8 x 23 5/8		37205	56-0049	21 1/4 x 32 3/4		
56-0205	12 3/4 x 21 5/8		38415	56-0014	21 1/2 x 29 1/2	ADT332N	27563
56-0041	12 7/8 x 21 11/16			56-0212	21 1/2 x 44 1/2		29046
56-0065	13 1/2 x 52 3/4	URS36DT	37504	56-0017	21 1/2 x 59 1/2	GHT232	27564
56-0026	14 1/2 x 23 1/2			56-0127	21 5/8 x 44 3/4		
56-0206	14 1/2 x 23 3/4		37557	56-0034	23 1/2 x 23 1/2		27568
56-0030	15 1/2 x 50 3/4	URDT224DUT		56-0012	23 1/2 x 29 1/2		27565
56-0125	15 1/2 x 59 3/4			56-0013	23 1/2 x 59 1/2	AHF232WP	27566
56-0206	15 3/4 x 40		37871	56-0038	23 5/8 x 42 1/4	RHT124WUT	
56-0035	16 3/4 x 44		27808				

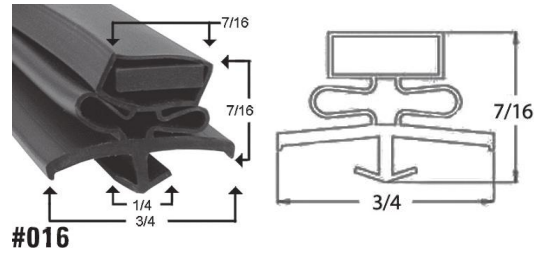

Dart Style Magnetic

SKU	Dim. (Inches)	Commonly Fits Models	OEM Part	SKU	Dim. (Inches)	Commonly Fits Models	OEM Part
57-0490	7 5/8 x 29 1/8	TRC-50/79		57-0086	18 5/8 x 40 5/8	GDM-35SL-RF	810441
57-0503	7 3/4 x 19 9/16		810992	57-0506	18 7/8 x 53 1/8		810765
57-0002	8 x 29 1/2	TRCB-50,TRCB-79	810764	57-0052	19 x 30	TBB-24-48,TBB2448	810759
57-0504	8 1/16 x 29 1/2		874665	57-0105	20 1/4 x 30	TBB-24-72,TBB-24-72FR	811136
57-0083	8 1/8 x 23 1/8	TRCB-36	922892	57-0036	21 x 30	TBB-1,TBB-1-S,TBB-2	810805
57-0051	8 1/8 x 29 5/8	TRCB-110,TRCB-48	810764	57-0492	23 1/8 x 26 3/4	TSSU/TUC/TWT-48/F	
57-0077	8 1/8 x 42 1/2	TRCB-52,TRCB-52-60	810720	57-0040	23 1/4 x 26 5/8	QA-48-18MB	810809
57-0084*	8 7/8 x 57 5/8	TMC-58-DS	810714	57-0507	24 x 26		874635
57-0075	12 3/8 x 28 1/2	TWT-60D-2	810513	57-0104	24 x 41 1/2	GDM-10RF	810762
57-0001	12 5/8 x 24 1/2	TPP-119D-2	810844	57-0087	24 x 50 1/4	GDM-12LE-RF	810761
57-0003	12 3/4 x 24 5/8	TPP-67,93,119	810844	57-0508	24 1/2 x 26		810912
57-0096*	12 3/4 x 33 1/2	TMC-34	810779	57-0038	24 3/4 x 26	TPP-119,TPP-119D-2	810812
57-0053	12 7/8 x 28 3/8	TPP-44D-2,TUC-44D-2	810782	57-0088	25 x 30	TBB-24-60,TBB-24-60FR	810786
57-0491*	12 7/8 x 48 3/4			57-0011	26 x 28	TPP-44,TPP44,TUC-44	810816
57-0110*	12 7/8 x 57 1/2	TMC-58	810847	57-0012	26 1/2 x 26 1/2	TSSU-27-08	810810
57-0004	13 1/8 x 23 1/8	TSSU/TUC/TWT-48	810854	57-0041	26 1/2 x 26 1/2	TSSU-27,TUC-27	
57-0050	13 1/8 x 29 1/8	TSSU-60-08D-2	810513	57-0039	26 3/4 x 29	QA-60-24MB-L	810813
57-0044	13 1/4 x 26 3/8	TSSU-27-08D-2	810815	57-0509	26 1/2 x 26 7/8		810818
57-0030	13 3/8 x 23 1/8	TSSU-48-12D-2	810854	57-0510	29 7/8 x 68 1/16		810765
57-0085	14 x 42 3/4	GDM-14, GDM-14RF	810773	57-0081*	30 x 68 1/8	TA1FRI-1S,TA1FRI1S	
57-0505	14 3/8 x 30 5/8		874646	57-0493*	30 x 73		
57-0097°	15 x 1 1/2	TMC-34,TMC-34-DS	810846	* 3 sided gasket ° 2 sided left gasket, 1 1/2" extends to the right * 2 sided right gasket, 1 1/2" extends to the left			
57-0098+	15 x 1 1/2	TMC-34,TMC-34-DS	810848				
57-0006	17 3/8 x 26 3/8	TSSU-36-08,TSSU3608	810713				
57-0007	17 1/2 x 26	TPP-60,TPP60	810780				

Most Popular Sizes

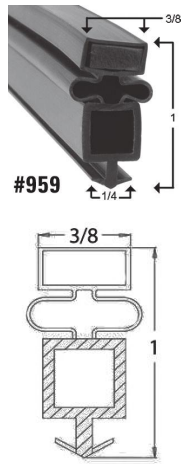

SKU	Dim. (Inches)	Commonly Fits Models	OEM Part	SKU	Dim. (Inches)	Commonly Fits Models	OEM Part
57-0015	13 x 28 1/4	TPP44D-2		57-0117	24 3/4 x 26	T726,T723G3,TS726	810993
57-0107	13 3/4 x 31 1/8	TCGD-31,TCGR-31		57-0530	24 7/8 x 31 1/8		810716
57-0016	18 1/2 x 54 1/8	GDM-35,T-35, T-35 G	810807	57-0497	24 7/8 x 63 3/8		810772
57-0031	18 1/2 x 54 1/8	GDM-35/T-35		57-0023	25 1/8 x 54 1/8	G4SM-23, G4SM-23FC	810801
57-0092	18 5/8 x 31 7/8	TBB-24-48G,TBB2448G	810766	57-0047	25 1/8 x 62 3/4	TM-24,TM-24F	810871
57-0106	20 1/4 x 31 3/4	TBB-24-72G	811142	57-0533	25 1/8 x 63		810824
57-0017	21 1/2 x 31 1/4	TBB-2G,TBB-3G		57-0024	25 1/4 x 26 5/16		810822
57-0054	21 7/8 x 31 3/4	TBB-2G,TBB-2G-S	810800	57-0060	25 1/4 x 26 3/4	TUC-27FG,TUC-27G	
57-0495	21 25/32 x 31 19/32	TBB-G		57-0025	25 5/8 x 25 7/8	T23-2	810878
57-0090	22 1/8 x 26 1/2	TUC-48G,TUC-48G-LP		57-0046	25 5/8 x 25 7/8	GDM-23-2, GDM-23F-2	
57-0512	22 3/8 x 54 1/8		810783	57-0028	25 5/8 x 26 5/8	T23-2,T-49-2-G-2,T-49-4	810808
57-0513	22 1/2 x 25		810859	57-0037	25 5/8 x 26 3/4	GDM-23-2, GDM-23F-2	
57-0514	22 27/32 x 35 11/32		872598	57-0537	25 5/8 x 31 5/16		810750
57-0014	22 7/8 x 36 1/8	GDM-7		57-0538	25 5/8 x 62 1/2		811110
57-0515	22 7/8 x 50 1/8		810437	57-0498	25 3/4 x 30 5/8	TM24-2	
57-0018	23 x 25 3/8	GDM-5		57-0499	25 3/4 x 31 1/2	TM52-4	
57-0057	23 x 25 1/2	GDM-05, GDM-05F		57-0055	25 5/8 x 42 1/4	GDIM-49, GDIM49	
57-0045	23 x 36 1/2	GDM-07, GDM-07		57-0026	25 3/4 x 54 1/8	GDM-47RL, GDM-49	
57-0516	23 1/4 x 41 11/16		810883	57-0034	25 3/4 x 54 1/8	GDM-49/T-49	810803
57-0056	23 1/4 x 50 3/8	GDM-12, GDM-12F		57-0027	25 3/4 x 63	GDM-52TM, GDM52TM	
57-0517	23 1/4 x 50 5/8		810850	57-0094	25 7/8 x 30 7/8	TM-52-4, TM52-4	810751
57-0019	23 1/4 x 51	GDM-12,T-12	810861	57-0093	25 7/8 x 31 3/4	TM-24-2, TM-24F-2	
57-0059	23 3/8 x 41 3/4	GDM-10, GDM10		57-0109	26 9/16 x 28 1/8	TUC-60G, TUC-60G-LP	
57-0049	23 3/8 x 50 1/2	GDM-12, GDM12		57-0058	26 7/8 x 27 7/8	T-28G-2, TS-28-2	810757
57-0020	23 3/8 x 56		810806	57-0103	27 9/32 x 31	TA1DT-2HS, TA1F-2HS	
57-0043	23 3/8 x 56 1/4	GDM-12, GDM-12FC		57-0102	27 5/8 x 30 9/16	TA1DT-2HS, TA1F-2HS	810778
57-0518	23 3/4 x 36 1/4		810837	57-0500	27 5/8 x 31 1/4		
57-0114	24 x 25 7/8	TS-53-4PT, TS534G4PT		57-0078	27 5/8 x 54	TS-28, TS-28-2PT	
57-0115	24 x 26 3/4	TS-53-4PT, TS534G4PT		57-0501	27 5/8 x 62 3/4	TG1R1S	
57-0116	24 x 54	TS-53-4PT, TS534G4PT		57-0502	27 3/4 x 25 7/8		810758
57-0525	24 1/8 x 25 7/8		810768	57-0541	27 3/4 x 31		810777
57-0021	24 1/8 x 62 7/8	TA2R-2S, TA3R-3S		57-0082	27 7/8 x 63	TA1F-1G, TA1F-1S	810771
57-0100	24 5/16 x 30 9/16	TA2DT-4HS	810717	57-0029	28 1/8 x 54 1/8	GDM-26	
57-0042	24 5/8 x 26 5/8	T-72-3-G-3, T-72-6		57-0035	28 1/8 x 54 1/8	GDIM-26NT, GDIM26NT	
57-0022	24 5/8 x 26 3/4		810811	57-0113	28 1/4 x 42	GDIM26, GDIM-26	
57-0101	24 5/8 x 31 3/8	TA2DT-4HS		57-0543	28 11/16 x 42		810858
57-0032	24 5/8 x 54 1/8	GDIM-72NT, GDM-72	810802	57-0544*	29 3/4 x 73		811132
57-0496	24 5/8 x 62 3/4	TM-74	810872				

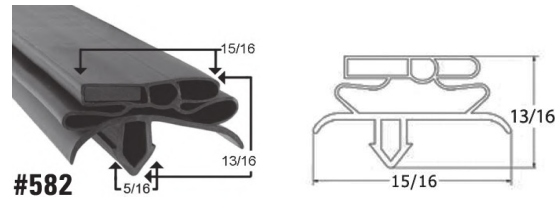
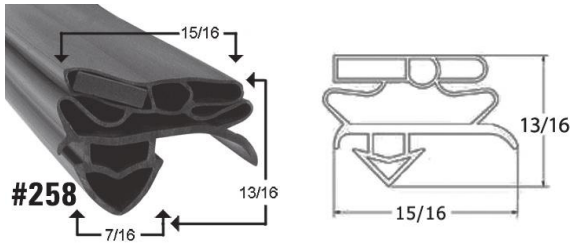

New Wide Dart Style

SKU	Dim. (Inches)	Commonly Fits Models	OEM Part
57-0063	19 3/8 x 54 1/4	CVM-35, GDM-35	811134
57-0065	23 1/4 x 25 3/8	GDM-05, GDM-05PT	811131
57-0095	23 7/8 x 42 5/16	GDM-10, GDM-10F	929086
57-0074	24 1/2 x 51 1/2	T-12, T-12F	811144
57-0073	25 3/4 x 54 5/8	GDIM-72NT, GDM-72	811135
57-0064	26 1/4 x 53 5/8	G4SM-23, G4SM23	811125
57-0061	26 1/4 x 62 3/4	GDM-52TM	912147
57-0062	26 3/4 x 54 1/4	CVM-49, G4SM-23	801719
57-0099	28 7/8 x 53 1/2	GDM-26, GDM-26F	811127

New Narrow Dart Style

SKU	Dim. (Inches)	Commonly Fits Models	OEM Part
57-0511	12 x 27 1/2		934758
57-0111	12 1/2 x 24 1/2	TPP-119D-2	934759
57-0108	13 1/2 x 28 7/16	TPP-44D-2, TUC-44D-2	934758
57-0089	17 1/2 x 26 3/4	TSSU-36-08	932585
57-0079	23 1/2 x 26 3/4	TSSU-48-08	932588
57-0494	23 3/8 x 26 1/2		932584
57-0091	24 3/8 x 26	TPP-119, TPP-119D-2	934757
57-0112	26 1/2 x 28	TPP-44, TUC-44	934755
57-0080	26 3/4 x 26 3/4	TSSU-27-08	932587
57-0076	27 1/4 x 29 1/2	TSSU-60-08	932586

TURBO AIR

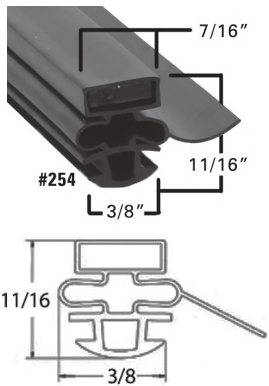

Push In

SKU	Dimensions (Inches)	Fits Models	OEM Part	SKU	Dimensions (Inches)	Fits Models	OEM Part
58-0018	8 x 42 3/4	TCBE52SDR	C962300100	58-0025	25 1/4 x 53		30223L0211
58-0017	16 1/2 x 26 3/4	TST-36SD-15		58-0012	25 1/4 x 53 1/4	TSR-49SD	30223L0212
58-0019	17 7/8 x 53	TSR35SD		58-0005	25 1/2 x 26 1/2	GUC28SF	M272300100
58-0021	21 1/2 x 31	TBB-2SG		58-0006	25 1/2 x 53 1/4	TSR-72SD	
58-0022	22 x 26 1/2		30223M0100	58-0013	25 1/2 x 53 1/2	TSF-49SD	
58-0014	22 x 54 1/2	GST40DRF		58-0020	26 1/2 x 53	TGM50RS	
58-0002	22 1/8 x 26 1/4	TST48SD-18		58-0016	26 5/8 x 28		30223110200
58-0023	22 1/2 x 26 3/4		M722300100	58-0008	26 5/8 x 28 3/8	GSP60D	
58-0001	22 1/2 x 52 1/4	TGM14RV		58-0015	26 3/4 x 61	M3F241	
58-0004	24 x 60 5/8	M3F472		58-0026	27 1/4 x 28 1/2		30223U0200
58-0003	24 1/4 x 26 3/4	TPR-67SD		58-0009	27 3/4 x 57 1/4	TGM22RV	
				58-0027	27 3/4 x 57 3/4		30223H0200

VICTORY

VICTORY

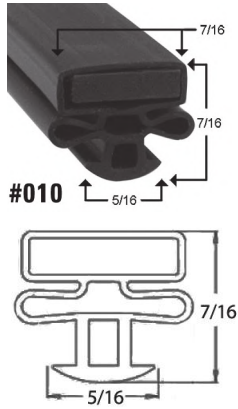

Glass Door

SKU	Dimensions (Inches)
62-0031	25 1/4 x 59 1/4

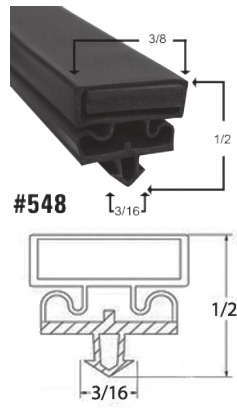

Glass Door

SKU	Dimensions (Inches)	OEM Part
62-0064	23 1/2 x 28 1/4	50876403
62-0084	25 1/2 x 51	

Most Popular Sizes

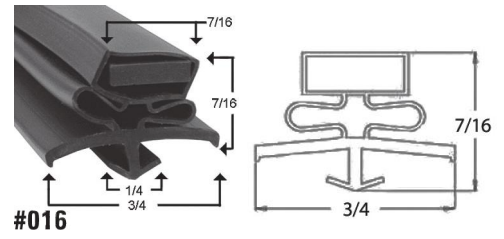

Dart Style

SKU	Dimensions (Inches)	Fits Models	OEM Part #
62-0082	53 length only		
62-0096	9 x 20		50701406
62-0063	19 3/4 x 23 7/8	UR412BTQ1	
62-0097	20 x 24		50751901
62-0035	21 x 24 5/8	PJPT88SK1	50753901
62-0098	23 5/8 x 26 1/2		50751801
62-0038	24 x 26 5/8		
62-0099	24 1/2 x 31		50837502
62-0083	24 7/8 x 31 1/4		

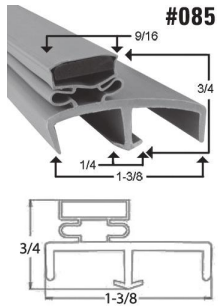

Dart Style

SKU	Dimensions (Inches)	Fits Models	OEM Part	SKU	Dimensions (Inches)	Fits Models	OEM Part
62-0060	16 5/8 x 25 1/8	GRS-2-S7	50596914	62-0020	25 1/8 x 30 3/8	AR-4752	50356301
62-0027	17 1/2 x 24 5/8		50596905	62-0010	25 1/4 x 58	VICTORY SRS 5	50600803
62-0100	23 3/8 x 62 1/4		50596908	62-0023	25 3/8 x 53 1/2	RS1DS5STS	50582903
62-0026	23 1/2 x 30 1/4		50596907	62-0032	28 1/4 x 33	RFA1DS6HD	50596911
62-0022	23 1/2 x 58	AF22S5	50596902	62-0059	30 1/4 x 33		50600806
62-0025	23 5/8 x 28 1/8	AF22S5HD	50596901	62-0024*	30 1/4 x 68	RISA-1D-S7	
62-0028	23 5/8 x 62 1/4		50596908	62-0087*	30 1/4 x 68 1/4		50359401
62-0050	24 1/4 x 30 1/4	RAE SRS 4 1/2 DOOR	50582901	62-0018	30 3/8 x 33 3/16		50356501
62-0051	24 1/4 x 62	RAE SRS 4 1/2 DOOR	50582902	62-0055*	30 3/8 x 73 3/4	DAR2DS5	50359406
62-0086	24 1/4 x 62			62-0041*	30 1/2 x 75 1/2		50359408
62-0085	24 3/4 x 30 1/4			62-0034	33 x 58 3/8		50596913
62-0061	25 x 26		50384312	*3 sides			
62-0019	25 x 28 1/4	50600802					
62-0021	25 x 62	FA2DS2	50356401				

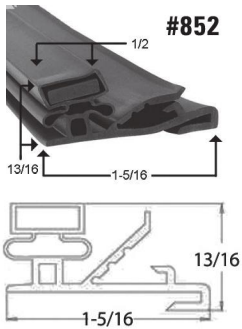

Glass Door

SKU	Dimensions (Inches)	Fits Models
62-0042	23 5/8 x 25 1/2	
62-0029	23 13/16 x 58 3/8	
62-0033	23 3/4 x 28 1/4	SR-47-S6-PT-HD
62-0037	25 3/8 x 57 1/2	
62-0030	25 13/16 x 51 3/16	
62-0017	26 x 63	LH
62-0088	26 x 63	RH

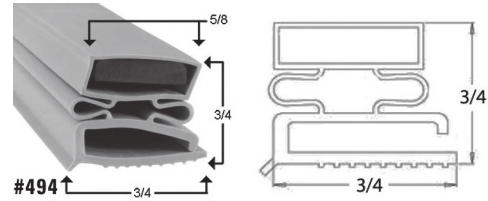

Screw In Style

SKU	Dimensions (Inches)	OEM Part
62-0108	7 1/2 x 24 7/8	50649303

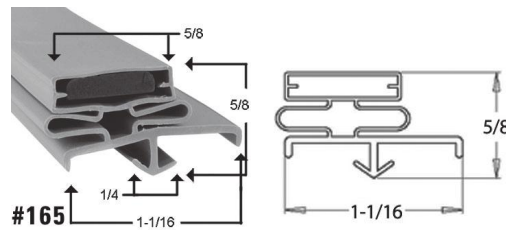

Dart Style

SKU	Dim. (Inches)	Fits Models	OEM Part	SKU	Dim. (Inches)	Fits Models	OEM Part
62-0036	8 x 24 1/4	GFS1S7RL, UR27SST	50701410	62-0105	23 1/8 x 57 1/2		50879501
62-0039	9 x 20 1/4			62-0065	23 3/16 x 27 3/4	RA1DS7PT	50879502
62-0089	10 1/2 x 23 5/16		50856101, 50856110	62-0005	23 1/4 x 58	VICTORY SRS 6 & 7	50596902
62-0040	11 1/2 x 25 1/2			62-0003	23 1/4 x 28 1/4	VICTORY SRS 6 & 7	50596901
62-0101	12 3/4 x 15 3/4		50630604	62-0004	23 1/4 x 30 1/4	VICTORY SRS 6 RED LOB.	50596907
62-0102	13 3/4 x 25 1/2		50630603	62-0006	23 1/4 x 62 1/4		50596908
62-0001	17 1/2 x 24 3/4	RUFS & RURS SRS 5-7	50596905	62-0107	23 1/2 x 26 1/8		54055601
62-0057	20 7/16 x 21 7/16	VUR418BT	50881501	62-0093	24 9/16 x 27 11/16		
62-0090	20 7/8 x 22 7/8			62-0094	24 11/16 x 27 3/4		
62-0103	21 x 22 3/4		50867001	62-0009	25 x 28 1/2	VICTORY SRS 5	
62-0056	21 1/2 x 24 1/2	VUR60SST, VUR6016	50881401	62-0014	25 1/4 x 13 1/2	URD 27W/DRAWERS	50630603
62-0002	22 x 28	UR & UF48 (2 SEC UC)	50630602	62-0015	25 1/4 x 28 1/4	UF-27, UR-27	50630601
62-0062	22 3/4 x 25	VUR-3-B-T, VUR3BT	50866901	62-0011	25 1/4 x 30 1/2	REACH-IN SRS 2 & 3	
62-0091	23 x 25			62-0013	25 1/4 x 53	AIR CURTAIN (ACRS)	50582903
62-0092	23 x 57 3/4		50827801	62-0012	25 1/4 x 62	50356401	50356401
62-0104	23 1/8 x 27 3/4		50827802	62-0095*	29 3/4 x 67 7/8		
62-0054	23 1/8 x 27 7/8	VPT-65	50879502	62-0016	30 1/4 x 33 1/4	DAR2DS5	50356505

*3 Sided

VOLLRATH

VOLLRATH

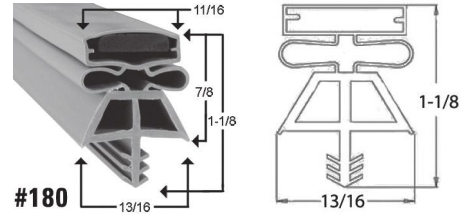
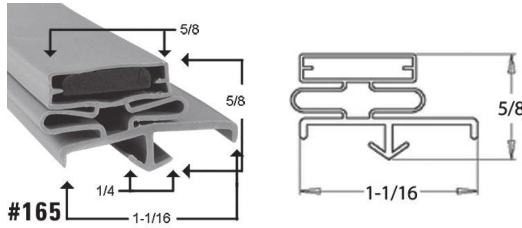

Dart Style

SKU	Dimensions (Inches)	OEM Part #	Hinge Side
63-0004	22 1/4 x 38 1/4		
63-0019	24 1/8 x 59 9/16	430827	
63-0005	26 x 73 3/4		
63-0020	28 5/8 x 67 7/8	203	
63-0021*	31 7/8 x 79	226181075	LH
63-0022*	31 7/8 x 79	226141075	RH
63-0023*	32 x 78 1/2	531472565	LH
63-0024*	32 x 78 1/2	531482565	RH
63-0006	32 1/4 x 32 5/8		
63-0007	32 1/4 x 38 1/4		
63-0001	32 1/4 x 77 3/4		
63-0002	32 1/4 x 79		
63-0025*	36 x 78		

***3 Sides**

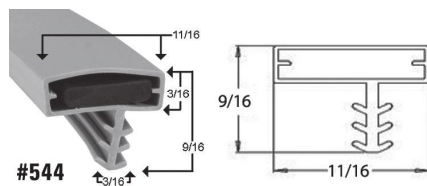

3 Sided Triple Dart Style

SKU	Dimensions (Inches)	OEM Part #
63-0048	36 1/2 x 78	255671075
63-0049	38 1/4 x 78	255681075

Triple Dart Style

SKU	Dimensions (Inches)	OEM Part #	Hinge Side
63-0014	26 1/4 x 77 1/2		
63-0035*	28 1/4 x 77 3/4	535142565	LH
63-0036*	28 1/4 x 77 3/4	535152565	RH
63-0037*	28 1/2 x 66	531172565	RH
63-0038*	28 1/2 x 66	531162565	LH
63-0018	32 1/4 x 77		
63-0015	32 1/2 x 75		
63-0039*	32 1/2 x 77	225151076	LH
63-0040*	32 1/2 x 77	225141076	RH
63-0041*	32 1/2 x 78	225151075	LH
63-0013	35 1/4 x 79 1/4		
63-0042*	35 3/8 x 77 1/4	255181075	
63-0043*	26 x 78	534822565	LH
63-0044*	26 x 78	225181075	RH
63-0011	36 1/4 x 78 1/4	225251075	
63-0045*	36 5/16 x 77 3/8	251811075	RH
63-0046*	37 7/8 x 77 7/8	225171075	LH
63-0047*	37 7/8 x 77 7/8	225161075	RH
63-0012	38 1/2 x 77 1/2		

***3 Sides**

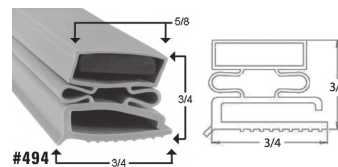

Screw In Gasket

SKU	Dimensions (Inches)
63-0016	32 1/2 x 77
63-0017	38 x 79

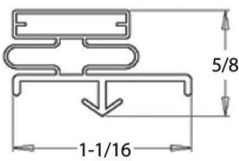
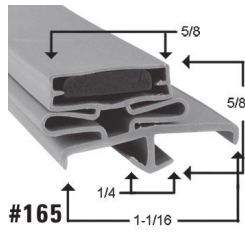

#165 (cont.)

Dart Style (cont.)

SKU	Dimensions (Inches)	OEM Part	Hinge Side
63-0026*	36 x 78	544822565	LH
63-0027*	36 x 78	544802565	RH
63-0009	36 x 78	18953, 1895	
63-0010	36 x 78 1/4	544822565	
63-0026	36 x 78 3/16	544821075	
63-0008	36 x 79 1/2		
63-0027*	36 x 79 3/4	09883	
63-0028	36 x 79 3/4	988	
63-0029*	36 1/16 x 78 1/2	225941075, 533112565	LH
63-0030*	36 1/16 x 78 1/2	225911075, 533122565	RH
63-0003	36 1/4 x 79		
63-0031*	38 x 78 3/4	531492565	LH
63-0032*	38 x 78 3/4	531502565	RH
63-0033*	38 1/4 x 77	226151075	RH
63-0034*	38 1/2 x 78 1/2	226191075	LH

*3 Sides

W.A. BROWN

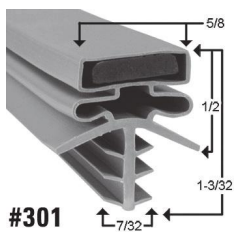

#301

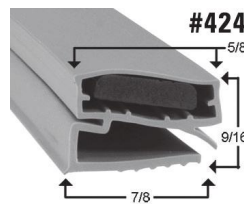
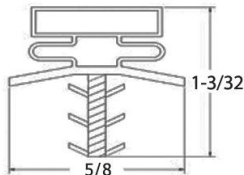

#424

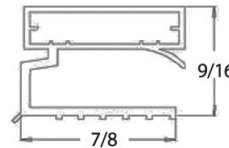

Triple Dart Style

SKU	Dimensions (Inches)
65-0004*	24 1/2 x 82 5/8
65-0003*	35 1/4 x 83 1/2

*3 sides

Screw In Style

SKU	Dimensions (Inches)
65-0005	25 3/4 x 65
65-0002	35 1/4 x 73
65-0001	35 1/2 x 77 3/4
65-0006	49 3/4 x 84 1/2
65-0008	50 1/2 x 78 1/2
65-0007	55 3/8 x 78 3/8

WASSERSTROM

WASSERSTROM

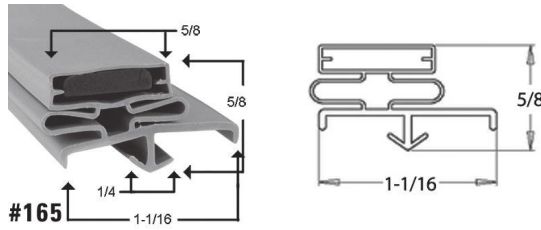

#165

Dart Style

SKU	Dimensions (Inches)	OEM Part
78-0001	11 x 22	3GKT2211
78-0002	22 ¼ x 24	3GKT2224

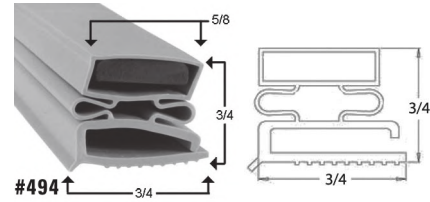

#494

Screw In Style

SKU	Dimensions (Inches)	OEM Part
78-0003	25 1/8 x 24	2GKT0043

ZERO ZONE

ZERO ZONE

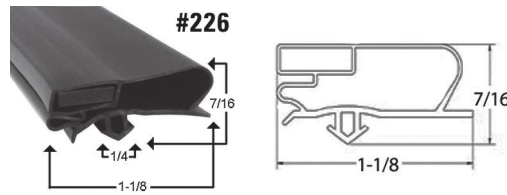

#226

Aircell Dart Style

SKU	Dimensions (Inches)	Commonly Fits Models	OEM Part
67-0008	23 1/8 x 54		750780
67-0005	29 ¼ x 62	3RMZP30, 4RMZC30, 3RMZC30	750778

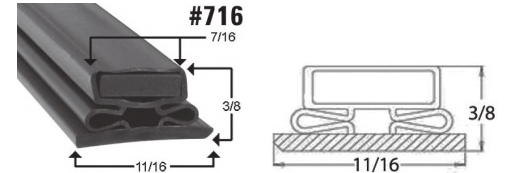

#716

Glass Door

SKU	Dimensions (Inches)
67-0002	21 7/8 x 53 ¼

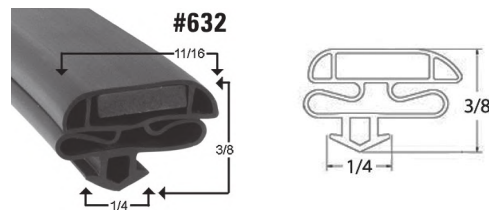

#632

Low Profile Dart Style

SKU	Dimensions (Inches)	Commonly Fits Models
67-0003	22 7/8 x 53 ¼	
67-0007	29 ¾ x 62 5/8	RI4DFRKT, RI5DFRKT

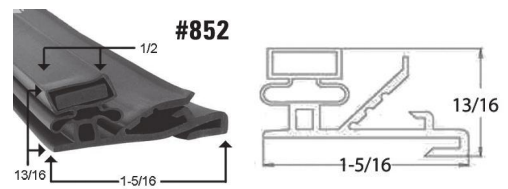

#852

Retainer Style

SKU	Dimensions (Inches)	OEM Part
67-0001	20 ¾ x 45 ¾	
67-0004	26 7/16 x 44 11/16	
67-0006	30 x 63 ½	75--0940

CUSTOM GASKET PROFILE NUMBERS

CUSTOM GASKET PROFILE NUMBERS

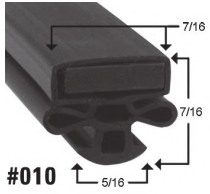

#010

SKU: 00-0010

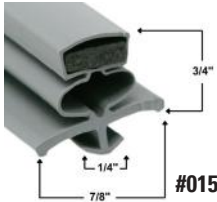

#015

SKU: 00-0015



#016

SKU: 00-0016

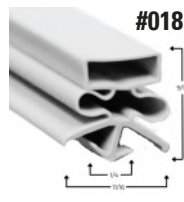

#018

SKU: 00-0018

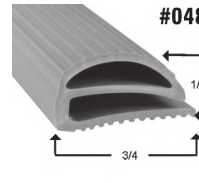

#048

SKU: 00-0048

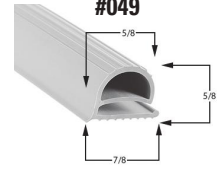

#049

SKU: 00-0049



#050

SKU: 00-0050

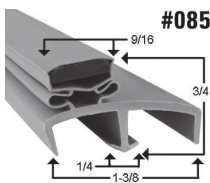

#085

SKU: 00-0085

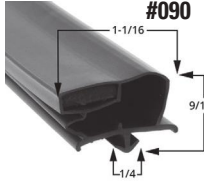

#090

SKU: 00-0090

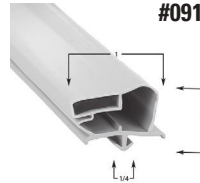

#091

SKU: 00-0091

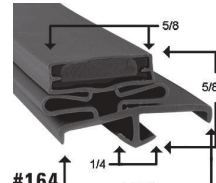

#164

SKU: 00-0164

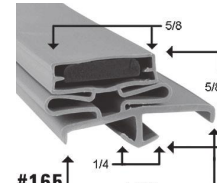

#165

SKU: 00-0165

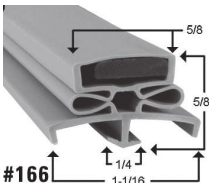

#166

SKU: 00-0166

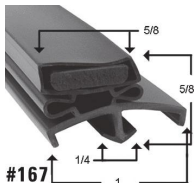

#167

SKU: 00-0167



#168

SKU: 00-0168

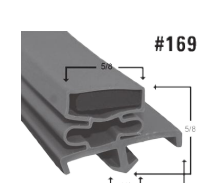

#169

SKU: 00-0169

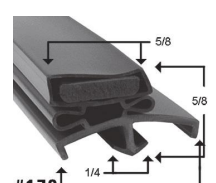

#170

SKU: 00-0170

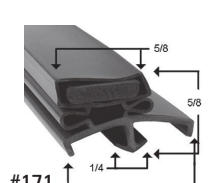

#171

SKU: 00-0171

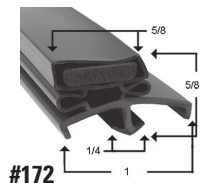

#172

SKU: 00-0172

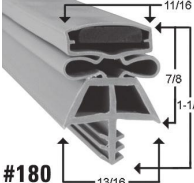

#180

SKU: 00-0180

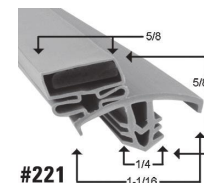

#221

SKU: 00-0221

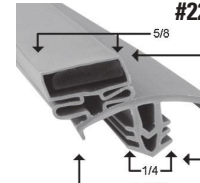

#223

SKU: 00-0223



#227

SKU: 00-0227



#228

SKU: 00-0228



#229

SKU: 00-0229



#230

SKU: 00-0230

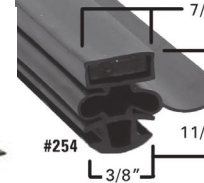

#254

SKU: 00-0254

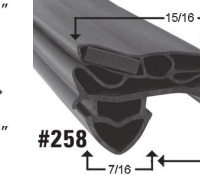

#258

SKU: 00-0258

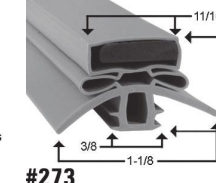

#273

SKU: 00-0273

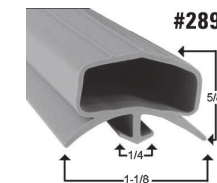

#289

SKU: 00-0289

CUSTOM GASKET PROFILE NUMBERS

CUSTOM GASKET PROFILE NUMBERS



SKU: 00-0290

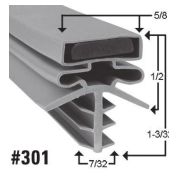

SKU: 00-0301

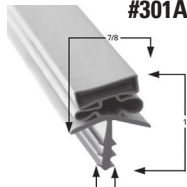

SKU: 00-0301A

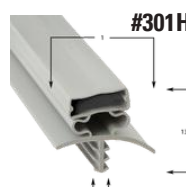

SKU: 00-0301H



SKU: 00-0306



SKU: 00-0309



SKU: 00-0310



SKU: 00-0327



SKU: 00-0365

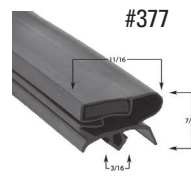

SKU: 00-0377

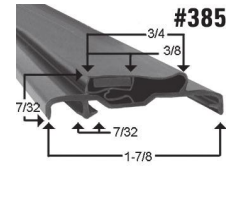

SKU: 00-0385

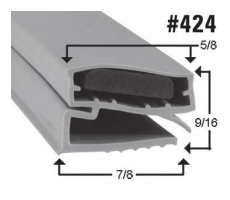

SKU: 00-0424



SKU: 00-0425



SKU: 00-0453



SKU: 00-0454



SKU: 00-0493

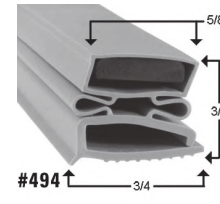

SKU: 00-0494

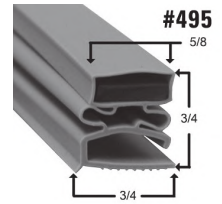

SKU: 00-0495

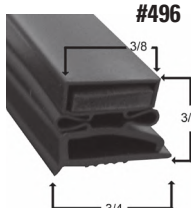

SKU: 00-0496

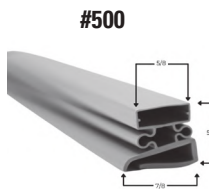

SKU: 00-0500

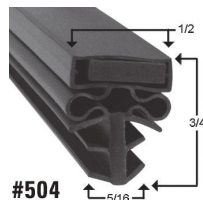

SKU: 00-0504

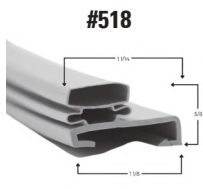

SKU: 00-0518

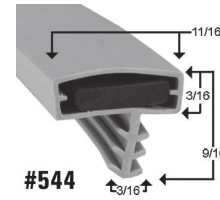

SKU: 00-0544

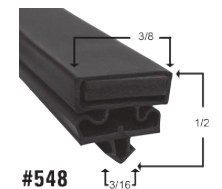

SKU: 00-0548



SKU: 00-0549

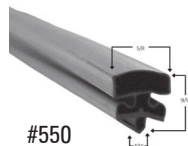

SKU: 00-0550



SKU: 00-0551

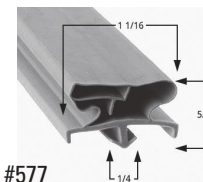

SKU: 00-0577

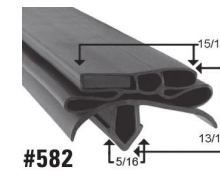

SKU: 00-0582

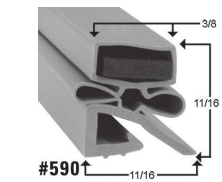

SKU: 00-0590

CUSTOM GASKET PROFILE NUMBERS

CUSTOM GASKET PROFILE NUMBERS

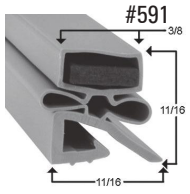

SKU: 00-0591

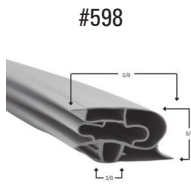

SKU: 00-0598



SKU: 00-0599

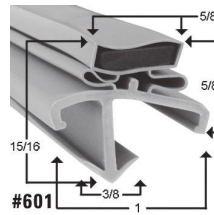

SKU: 00-0601

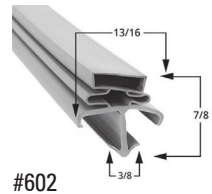

SKU: 00-0602

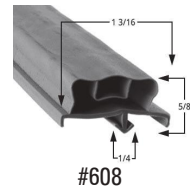

SKU: 00-0608

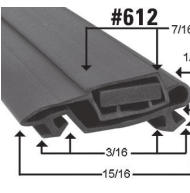

SKU: 00-0612



SKU: 00-0618



SKU: 00-0619



SKU: 00-0620

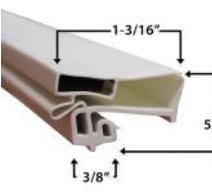

SKU: 00-0627

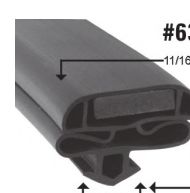

SKU: 00-0632

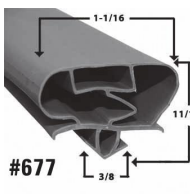

SKU: 00-0677

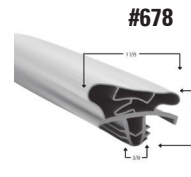

SKU: 00-0678

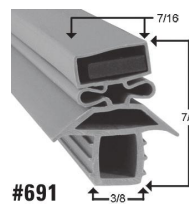

SKU: 00-0691



SKU: 00-0697

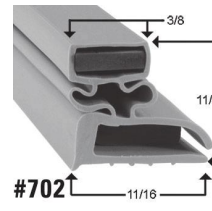

SKU: 00-0702

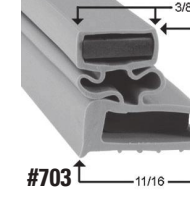

SKU: 00-0703

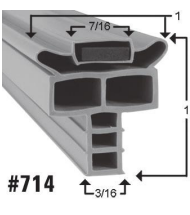

SKU: 00-0714

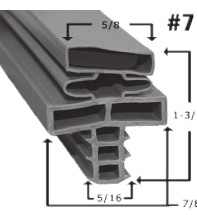

SKU: 00-0715

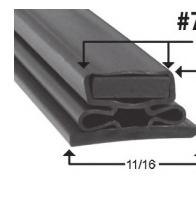

SKU: 00-0716

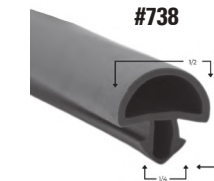

SKU: 00-0738

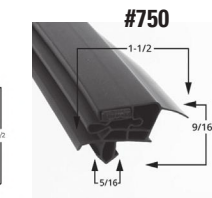

SKU: 00-0750

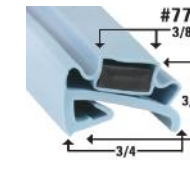

SKU: 00-0770

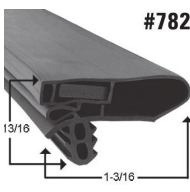

SKU: 00-0782

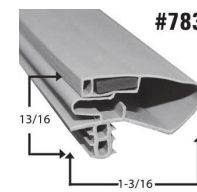

SKU: 00-0783

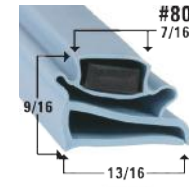

SKU: 00-0802

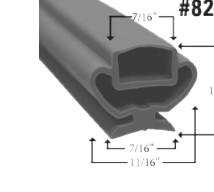

SKU: 00-0829

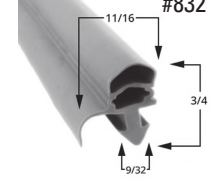

SKU: 00-0832

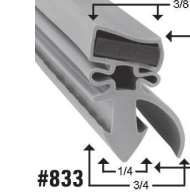

SKU: 00-0833

CUSTOM GASKET PROFILE NUMBERS

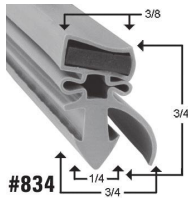

#834

SKU: 00-0834

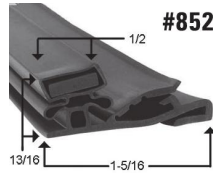

#852

SKU: 00-0852

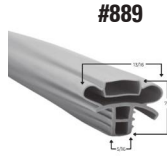

#889

SKU: 00-0889

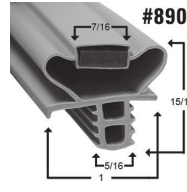

#890

SKU: 00-0890

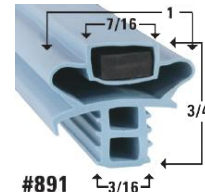

#891

SKU: 00-0891

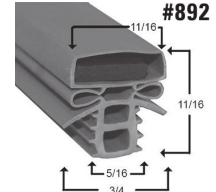

#892

SKU: 00-0892

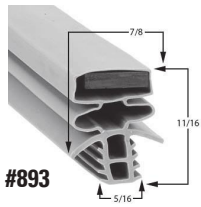

#893

SKU: 00-0893



#894

SKU: 00-0894



#895

SKU: 00-0895



#896

SKU: 00-0896

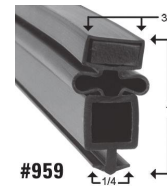

#959

SKU: 00-0959

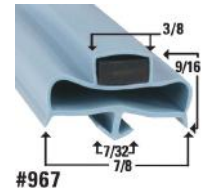

#967

SKU: 00-0967



#3346

SKU: 00-3346

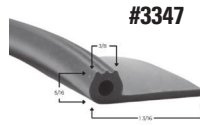

#3347

SKU: 00-3347

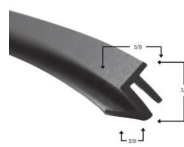

#3401

SKU: 00-3401

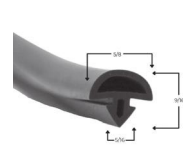

#5005

SKU: 00-3738

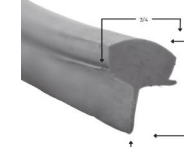

#5005

SKU: 00-5004

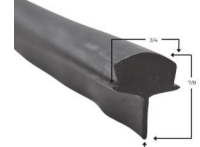

#5005

SKU: 00-5005

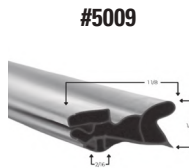

#5009

SKU: 00-5009



#5730

SKU: 00-5730

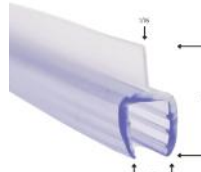

ANTHONYVISTA GASKET

CUSTOM RETAINER PROFILE NUMBERS



#201

Retainer
SKU: 96-0201
8' Stick for use with profiles #164-170



#202

Retainer
SKU: 96-0202
8' Stick for use with most screw in type gaskets



#225

Retainer
SKU: 96-0225
8' Stick for use with profiles #226 and #227



#364

Retainer
SKU: 96-0364
8' Stick for use with profile #365



#611

Retainer
SKU: 96-0611
8' Stick for use with profile #612

HOW TO MEASURE A GASKET

How to Measure Outside Edge to Outside Edge

All measurements are noted as outside edge to outside edge dimensions. Please follow the instructions below to properly measure your gasket:



Take a look at the gasket currently on the door and match the style up to one of the gasket profiles.



Using a tape measure, measure the outside edge of the gasket that is currently on the door. If the gasket seems to be stretched or warped a bit, don't worry, as long as you are within $\frac{1}{8}$ inch, the replacement gasket should install properly.



Most refrigeration door gaskets are 4 sided, but when you are working with large walk in cooler doors, you will find many of those are 3 sided gaskets with no bottom. If the gasket is NOT 4 sided, then you will need to specify which sides you would like us to include. Typically on 3 sided gaskets the bottom is a door sweep.

How to Measure if the Gasket is Torn or Missing

Follow these instructions on how to measure if the original gasket is torn or missing.

Model # Serial #

True Manufacturing Co.
1-2382822

Model # 1-2382822

Serial # 1-2382822

OPTION #1

Locate the model and serial number of your equipment. Usually they are located on a data plate similar to the one above. Give us a call and we will help locate the correct profile.



Using a tape measure, measure from the center of the dart track to the center of the opposite dart track that is on the door.

OPTION #2



When placing your order note that the dimensions are dart to dart and we will convert your measurements to outside edge dimensions.

HEATER WIRE INFORMATION

What is a Door Heater?

A door heater is a 120v braided wire placed around the outside of the door frame that prevents doors from freezing closed.



4 Sided



3 Sided - Double Loop

To Order Please Provide the Following:

1. Length of heater wire not including leads
2. If not available, we will need to know the door opening and if the heater wire is 3 or 4 sided

STRIP CURTAIN GUIDE

Ordering Guide for strip curtains

1. Is your walk in a freezer or cooler? Use medium temp curtains for a cooler and low temp curtains for a freezer.
2. How much overlap do you want for the curtains? 33% is typical for coolers and 50% for freezers.
3. Allow for 1 inch on either side when calculating width for the mounting bracket. Example: 36" door will use a 38" bracket. This allows for coverage for any gaps on either side of the outside strips.
4. Add 3 inches for the height of the opening to allow for mounting the bracket above the top of the opening. Ex: If your opening is 84" make the strips 87" long.
5. Do you need reinforced curtains? These are used in freezer and high traffic environments to help reduce replacement.



PRO Tip

Strip curtains reduce energy costs! Completely customizable, in stock, and can ship today!



PRO Tip

When ordering strip curtains please note the strip width, height, and overlap needed.

HINGE INSTALLATION

What is Offset?

Offset on refrigerator doors is the difference, in inches, between the outside surface of the frame or cabinet to which the door seals and the face of the door. Shown below are different ways to measure the offset:

Determining the Offset of Existing Edgemount Hinges

The offset of an edgemount hinge is determined by one of two different methods based on the manufacturer. See examples below:

- A.** Offset measured to centerline of hole. **B.** Offset measured to edge of hinge (Kason mostly)



Distance inbetween arrows is equal to offset of hinge.



Determining the Offset of Facemount or Strap-Type Hinges

Measure from the hinge base to level position of the strap. Manufacturer will stamp offset on hinge butt or on hinge blade. If conflicting information is given on both butt and blade, figure shown on blade will be the correct offset.



Measuring the Offset of a Door



Measure distance from the surrounding cabinet surface to the door face. The measurement will be the "offset" of the door.

HOW TO REVERSE HINGES

Edgemount Hinge

Reversing CAM-LIFT Hinge Direction (Edgemount Door Hinges)

Pry cam upward with screw driver

Rotate cam 180° and reset



Facemount Hinge

Hinge Direction Left or Right?

Hinge set for left-hand operation



Hinge set for right-hand operation



Walk-In Hinge

Reversing Hinge Direction

A. Remove pin

B. Rotate the hinge butt and blade. You will need to restack any bearings or washers. The hinge blade should turn on top of the bearings.

C. Replace the hinge pin to complete reversing hinge. Hinge pin should always be inserted from top side of hinge.

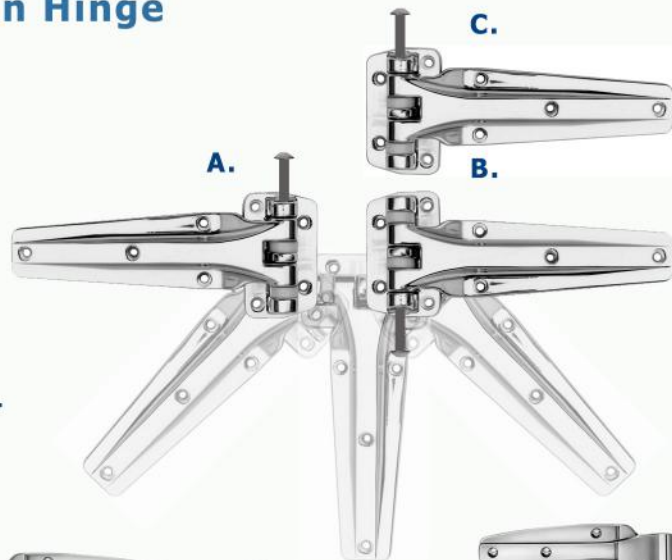

Reversing CAM-LIFT Hinge Direction (Strap-type door hinges)



1. Hinge set for left hand door

2. Separate door wing from hinge wing

3. Remove cap
4. Remove cam

5. Replace cam
6. Replace cap

7. Reset hinge for right hand operation

CUSTOM GASKET ORDER FORM

Name: _____ PO#: _____

Company Name: _____

Phone Number: _____ Email Address: _____

Street address: _____ City: _____ State: _____ Zipcode: _____

IMPORTANT: Make sure you double check your dimensions and note if they are outside edge dimensions or dart to dart.

1. Select a profile from the diagram
2. Measure from outside edge to outside edge of the gasket
3. Note if gasket is 3 sided or 4 sided.

	 Length (In)	_____ Profile #
		_____ Quantity
<input type="checkbox"/> 3 Sided <input type="checkbox"/> 4 Sided		

Width (In)

Gasket Tag: _____

	 Length (In)	_____ Profile #
		_____ Quantity
<input type="checkbox"/> 3 Sided <input type="checkbox"/> 4 Sided		

Width (In)

Gasket Tag: _____

	 Length (In)	_____ Profile #
		_____ Quantity
<input type="checkbox"/> 3 Sided <input type="checkbox"/> 4 Sided		

Width (In)

Gasket Tag: _____

	 Length (In)	_____ Profile #
		_____ Quantity
<input type="checkbox"/> 3 Sided <input type="checkbox"/> 4 Sided		

Width (In)

Gasket Tag: _____

TERMS AND CONDITIONS

Prices

Due to market fluctuations we reserve the right to change pricing without notice. Working on a job or need an official written quote? No problem! We can provide you a quote that is valid for 30 days. Prices do not include shipping charges.

No Minimum Orders!

There is never a minimum order requirement! Order only what you need, when you need it. Need a large quantity of a single item? Volume pricing may be available. Please call for details.

Special Orders

If an item is not shown in our catalog we will work hard to find it and order it for you. We may ask you to send a sample of the old gasket or part. Per your request we will return the sample upon request. Lead times will vary on special order items and they are non-returnable.

Quality Counts!

Our gaskets are made 100% in the USA! Not only is our gasket material from the USA, but our gaskets are also manufactured in the United States.

Products shown in our catalog may not be purchased directly from the Original Equipment Manufacturer (OEM). [Gaskets Unlimited](#) knows our products meet or exceed the OEM standards. Please note the use of OEM part numbers are provided as reference only. They do not imply the item was purchased from a specific OEM. Our products are not endorsed, sponsored, approved, or authorized by the OEM. All OEM names in our catalog are registered trademarks.

Responsibility

Information in our catalog has been reviewed and we believe it to be generally correct. We do not guarantee it. All images, photos, notes, and illustrations are considered to be representations of the actual product and are only intended to give an idea of what the product looks like. In some cases, slight variations may apply and change over time.

Shipping

Most orders will ship within 1-3 business days. Special orders or out of stock items will ship as fast as possible. We ship most orders by UPS, however, some may ship via freight liner due to weight or size. We take extra time to make sure each product is packaged with care and attention. If your products are damaged in transit you are responsible for notifying the carrier ASAP and filling claim forms as per the carrier requirements. Please save all of your packaging exactly as it was received. We will work with you to get a replacement out ASAP.

Returns

When you purchase a gasket from [Gaskets Unlimited](#) we want you to feel confident that your purchase is backed by our [Gaskets Unlimited 30-Day 100% Guarantee](#). If you are not completely satisfied with the quality of the gaskets you purchased, contact our customer service department immediately and we will do everything in our power to correct the problem. If we cannot do this, we will authorize a 100% refund of the cost of your gasket or an exchange for another product. We'll make sure you have a gasket that works for your unit!

All of our OEM Quality gaskets are custom-made to order. Please follow our measuring instructions carefully before placing your order.

- We want to make sure you end up with the right gasket for your unit on your first try. If you made a measuring mistake or an incorrect profile choice on your gasket order, notify us within 30 days and we will offer 100% of your incorrect gasket's cost as in-store credit toward your correct gasket order! You only need to pay if there is a difference in price between your old and new gasket.
- On all other products in our catalog, you are allowed up to 30 days from date of shipment to request a return. Products must be returned in new condition. Shipping costs to return the items are the responsibility of the customer. Non-inventory, special order, and custom products are non-returnable.

Other Policies

Please notify us ASAP of any error in your order. We do our best to ensure accuracy, but we are not perfect. Please check your packing slips and call if you have any questions.

We reserve the right to correct any clerical errors or typos in quotes, invoices, statements, etc.

Neither we nor the manufacturer shall be liable for any injury, loss, or damage that arises from use or inability to use any product sold by us.

Open accounts may be arranged by contacting our customer service team. We reserve the right to cancel open accounts at any time for any reason. Open accounts are Net 30 terms. We charge a \$75 service fee for each NSF check. We gladly accept payment via major credit card and debit card (Visa, Mastercard, Discover, and American Express).

Copyright Notice

The contents of this catalog including images, illustrations, text, and entire contents of this catalog are copyrighted under the United States copyright laws. Nothing contained in this catalog grants any license or right to use any materials in this catalog without the written permission of [Gaskets Unlimited](#) or such party that may own the materials.

GASKETS UNLIMITED

3001 McCall Drive
Atlanta, GA 30340



SAVE | ORDER
TIME | ONLINE

Place orders online via our website.
Contact us if you need your
login credentials.

Phone: (877) 542-7538 • Fax: (877) 503-7443 • Email: orders@gasketsunlimited.com

GLASS DOOR PARTS • CUTTING BOARDS • STRIP CURTAINS • HARDWARE • GASKETS